

---



**METTLER TOLEDO**

# **PS**

## **Shipping Scales**

**Operator / Technical  
Manual**

**with GeoCal™ and USB**

©**METTLER TOLEDO**. 2009

No part of this manual may be reproduced or transmitted in any form or by any means, electronic or mechanical, including photocopying and recording, for any purpose without the express written permission of **METTLER TOLEDO**.

U.S. Government Restricted Rights: This documentation is furnished with Restricted Rights.

**METTLER TOLEDO**

# Publication Problem Report

If you find a problem with our documentation, please complete and fax this form to (614) 438-4355

Publication Name: \_\_\_\_\_

Publication Part Number: \_\_\_\_\_ Publication Date: \_\_\_\_\_

PROBLEM(S) TYPE:	DESCRIBE PROBLEM(S):	INTERNAL USE ONLY
<input type="checkbox"/> <b>Technical Accuracy</b>	<input type="checkbox"/> Text <input type="checkbox"/> Illustration	
<input type="checkbox"/> <b>Completeness</b> What information is missing?	<input type="checkbox"/> Procedure/step <input type="checkbox"/> Illustration <input type="checkbox"/> Definition <input type="checkbox"/> Example <input type="checkbox"/> Guideline <input type="checkbox"/> Feature <input type="checkbox"/> Explanation <input type="checkbox"/> Other (please explain below)	<input type="checkbox"/> <i>Info. in manual</i>  <input type="checkbox"/> <i>Info. not in manual</i>
<input type="checkbox"/> <b>Clarity</b> What is not clear?		
<input type="checkbox"/> <b>Sequence</b> What is not in the right order?		
<input type="checkbox"/> <b>Other Comments</b> Use another sheet for additional comments.		

Your Name: \_\_\_\_\_ Location: \_\_\_\_\_

Phone Number: ( ) \_\_\_\_\_

Fax this completed form to MTWT at (614) 438-4355

## **INTRODUCTION**

This publication is provided as a guide for individuals in the operation, use, and care of this METTLER TOLEDO product.

Further information or assistance regarding this product may be obtained by writing to:

### **METTLER TOLEDO**

1900 Polaris Parkway  
Columbus, OH 43240-2020  
(614) 438-4400

## **WARNING!**

This equipment generates, uses, and can radiate radio frequency energy and if not installed and used properly, i.e., in accordance with the instructions manual, may cause harmful interference to radio communications. It has been tested and found to comply with the limits for a Class A computing device pursuant to Subpart J of Part 15 of FCC Rules, which are designed to provide reasonable protection against such interference when operated in a commercial environment. Operation of this equipment in a residential area may cause interference, in which case the user at his own expense will be required to take whatever measures may be required to correct the interference.

**METTLER TOLEDO RESERVES THE RIGHT TO MAKE REFINEMENTS OR  
CHANGES WITHOUT NOTICE.**

**METTLER TOLEDO RESERVES THE RIGHT TO MAKE REFINEMENTS OR  
CHANGES WITHOUT NOTICE.**

---



# PRECAUTIONS

READ this manual BEFORE operating or servicing this equipment.

FOLLOW these instructions carefully.

SAVE this manual for future reference.



DO NOT allow untrained personnel to operate, clean, inspect, maintain, service, or tamper with this equipment.

ALWAYS DISCONNECT this equipment from the power source before cleaning or performing maintenance.

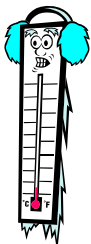

CALL METTLER TOLEDO for parts, information, and service.

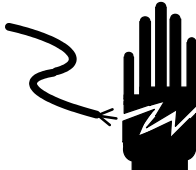

Note: If the unit has been stored or transported in below freezing temperatures, allow the unit to warm up to room temperature before turning on AC power.

	 <b>WARNING</b>
	<b>DISCONNECT ALL POWER TO THIS UNIT BEFORE INSTALLING, SERVICING, CLEANING, OR REMOVING THE FUSE. FAILURE TO DO SO COULD RESULT IN BODILY HARM AND/OR PROPERTY DAMAGE.</b>

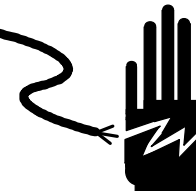
	 <b>CAUTION</b>
	<b>OBSERVE PRECAUTIONS FOR HANDLING ELECTROSTATIC SENSITIVE DEVICES.</b>

	 <b>WARNING</b>
	<b>ONLY PERMIT QUALIFIED PERSONNEL TO SERVICE THIS EQUIPMENT. EXERCISE CARE WHEN MAKING CHECKS, TESTS AND ADJUSTMENTS THAT MUST BE MADE WITH POWER ON. FAILING TO OBSERVE THESE PRECAUTIONS CAN RESULT IN BODILY HARM.</b>

	 <b>WARNING</b>
	<b>FOR CONTINUED PROTECTION AGAINST SHOCK HAZARD, CONNECT TO PROPERLY GROUNDED OUTLET ONLY. DO NOT REMOVE THE GROUND PRONG.</b>

 <b>CAUTION</b>
<b>BEFORE CONNECTING OR DISCONNECTING ANY INTERNAL ELECTRONIC COMPONENTS OR INTERCONNECTING WIRING BETWEEN ELECTRONIC EQUIPMENT, ALWAYS REMOVE POWER AND WAIT AT LEAST THIRTY (30) SECONDS BEFORE ANY CONNECTIONS OR DISCONNECTION'S ARE MADE. FAILURE TO OBSERVE THESE PRECAUTIONS COULD RESULT IN DAMAGE TO OR DESTRUCTION OF THE EQUIPMENT, OR BODILY HARM.</b>



# CONTENTS

## Operator Manual

<b>1</b>	<b>Introduction .....</b>	<b>1-1</b>
	Standard Features .....	1-2
	Optional Accessories .....	1-3
	Specifications .....	1-4
	Physical Dimensions.....	1-4
	Power Requirements .....	1-5
	Environmental Requirements .....	1-5
	Standards Compliance.....	1-6
	RF Susceptibility.....	1-6
<b>2</b>	<b>Installation .....</b>	<b>2-1</b>
	Unpacking and Setup.....	2-1
	Scale Installation.....	2-1
	Installation of Accessories.....	2-8
	Remote Display Installation .....	2-8
	Installing the Ball or Roller Top Transfer Platter .....	2-11
	Installing PS90 Conveyor Drop in Kit.....	2-11
<b>3</b>	<b>Operating Instructions and Maintenance.....</b>	<b>3-1</b>
	Power Up Sequence .....	3-1
	Keypad and Display .....	3-2
	The Display.....	3-2
	Keys and Navigation .....	3-2
	Operator Functions .....	3-3
	Parcel Weighing .....	3-3
	Unit Switching .....	3-3
	Zeroing the Scale .....	3-3
	Cleaning and Regular Maintenance .....	3-4

## Technical Manual

<b>4</b>	<b>Setup Parameters and Calibration .....</b>	<b>4-1</b>
	Remove Cal Jumper (Metrology lock) .....	4-1
	PS Scale Program Menu .....	4-2
	Configuring Setup Parameters.....	4-3
	Push Button Zero Program Block .....	4-4
	Zero Cursor Program Block .....	4-4
	Power-up Unit Program Block .....	4-5
	Build Program Block .....	4-5
	Alternate Units Program Block .....	4-6
	Mode Program Block.....	4-7



Filter Program Block .....	4-7
Baud Program Block.....	4-7
ASCII Program Block.....	4-8
Parity Program Block.....	4-8
Stop Program Block.....	4-8
Protocol Program Block.....	4-8
Sleep Program Block .....	4-9
GeoCal™ Program Block .....	4-9
Calibration Weight Program Block .....	4-9
Calibration Program Block.....	4-10
End Program Block.....	4-11
<b>Metrology Seal Installation .....</b>	<b>4-12</b>

<b>5 Service and Repair.....</b>	<b>5-1</b>
<b>Troubleshooting.....</b>	<b>5-1</b>
Error Code Section .....	5-2
Wall Transformer .....	5-2
Blank Display .....	5-3
No Keypad Interaction.....	5-3
Indicator Locked.....	5-3
<b>Serial Communication Test.....</b>	<b>5-4</b>
<b>Update Processor or Scale Software.....</b>	<b>5-7</b>
<b>Replace Main PCB .....</b>	<b>5-8</b>
<b>Load Cell Replacement .....</b>	<b>5-9</b>
<b>Installing the Base Mounted Display.....</b>	<b>5-11</b>

<b>Appendix A: RS232 Host Interface.....</b>	<b>A-1</b>
<b>Communication Parameters .....</b>	<b>A-1</b>
<b>Protocols .....</b>	<b>A-1</b>
ASCII Characters and Conversions.....	A-2
Toledo Protocol Host Commands.....	A-4
<b>Scale Status Byte Format.....</b>	<b>A-5</b>
<b>Scale Confidence Byte Format.....</b>	<b>A-5</b>
<b>Calibrate Using Host Interface .....</b>	<b>A-6</b>
<b>Configure Scale Parameters Using Host Interface.....</b>	<b>A-7</b>

<b>Appendix: USB Host Interface .....</b>	<b>B-1</b>
<b>References .....</b>	<b>B-1</b>
<b>Hardware.....</b>	<b>B-1</b>
<b>Electrical Connection .....</b>	<b>B-1</b>
<b>Power .....</b>	<b>B-2</b>
<b>Protocol.....</b>	<b>B-2</b>

# OPERATOR MANUAL

## 1

### Introduction

Thank you for purchasing a PS shipping scale from METTLER TOLEDO.

The PS scale, like all METTLER TOLEDO products, is designed for maximum durability and reliability in even the most demanding shipping applications. The PS is manufactured in one of METTLER TOLEDO's ten ISO 9000 certified facilities so you are assured to receive a high-quality product.

The PS scale is designed for robust use in parcel shipping, mail, and other light industrial environments. PS scale models have a wide temperature and humidity range and can be used on most unheated shipping docks.

The PS scale is a low profile, high precision scale designed to meet the needs of the legal-for-trade parcel/manifest markets. The PS scale is capable of communicating through Mettler Toledo standard and SICS protocol or in the protocols of the major shipping carriers. The scale program can be customized or quickly programmed in a one step process through default communication settings of the major shipping carriers. For preconfigured models, set up is simple and easy with plug and play capability.

The PS scale family has 4 main models with maximum capacity at 15 kg (30 lb), 30 kg (70 lb), 60 kg (150 lb) and 150 kg (300lb). There are three postal versions with high resolution to process letters as well as parcels. Typical PS models and platter options are summarized in the chart below. See the "Build" program block in Chapter 4 for the exact capacity / increment options.

	Letter & Parcel			Parcel				
	Provides high resolution required for shipping via USPS & Parcel Carriers			Superb reliability for retail stores, mail rooms and shipping departments sending packages via Parcel Carriers or Truck Lines				
	PS15	PS3L	PS6L	PS15	PS30	PS60	PS90 (150 lb)	PS90 (300 lb)
<b>Capacity</b>	30 lb 15 kg	70 lb 30 kg	150 lb (lb only)	30 lb 15 kg	70 lb 30 kg	150 lb 60 kg	150 lb 90 kg	300 lb 150 kg
<b>Readability</b>	0-15lb x 0.1oz 15-30lb x 0.2oz ----- 0-3kg x 0.001kg 3-15kg x 0.005kg	0-7lb x 0.1oz 7-70lb x 0.2oz ----- 0-15kg x 0.005kg 15-30kg x 0.01kg	0-10lb x 0.1oz 10-70lb x 0.2oz 70-149lb x 0.5oz ----- 0-5lb x 0.005lb 5-25lb x 0.05lb 25-150lb x 0.1lb	0.01lb 0.005kg	0.05lb 0.02kg	0.05lb 0.02kg	0.05lb 0.02kg	0.1lb 0.05kg
<b>Platter Construction</b>	ABS Plastic	ABS Plastic Stainless Steel	ABS Plastic Stainless Steel Ball Top	ABS Plastic	ABS Plastic Stainless Steel	ABS Plastic Stainless Steel Ball Top Roller Top	Stainless Steel Ball Top Roller Top	Stainless Steel Ball Top Roller Top
<b>PC Connection*</b>	USB RS-232	USB RS-232	USB RS-232	USB RS-232	USB RS-232	USB RS-232	USB RS-232	USB RS-232
<b>Approvals</b>	EC / OIML NTEP / UL	NTEP / UL	NTEP / UL	EC / OIML NTEP / UL	NTEP / UL	EC / OIML / NTEP Measurement Canada / UL	NTEP / UL Measurement Canada	NTEP / UL Measurement Canada

The PS90 and the PS60 both have 60 kg (150 lb) capacities. The PS90 (150 lb) version is utilized for the applications that need a larger platter size.

PS6L, PS3L, and version of the PS15 have multi-interval technology for high resolution, auto-ranging scales that are approved as weight classifiers for letters as well as parcels. It is like having multiple scales in one.

Additional Information can be gotten from the MT website to help in installation and operation of the scale:

[www.mt.com/ind-psscale](http://www.mt.com/ind-psscale)

In the unlikely event you experience difficulties operating your scale, please contact your local distributor or METTLER TOLEDO representative from whom you purchased the scale.

---

## Standard Features

The following are standard features built into each PS shipping scale.

- High quality Mettler Toledo precision load cell that is capable of being programmed for Lb, Kg or both (Units are selectable with the Units key)
- Multi-interval capacities that provide better weight resolution at the lower range. Scale has auto range capability to automatically switch between intervals.
- GeoCal Setup compensates the sensitive factory calibration for local gravitational differences, eliminating the expense of an onsite calibration.
- O270, 2-key display for easy to read weight indication and programming of the scale.
- Capable of communicating via USB or RS232. For USB, the PS scale uses the POS HID scale protocol.
- Selectable communication protocols to match major carrier or manifest software's
- USB Cable (6 ft)
- RS-232 serial interface cable (10 ft)
- Universal Power adapter with localized plug (Used with RS232 communication only, Scale is self powered through USB connection)

The following features are specific to the following PS models:

PS15:

- 30 lb / 15 Kg capacity
- Coated steel plate for base and sub-platter
- Base mounted display
- Plastic platter

### PS30:

- 70 lb / 30 Kg capacity
- Die-cast aluminum base and sub-platter
- Base mounted display
- Plastic or stainless steel platter

### PS60:

- Standard Capacity 150 lb / 60 Kg
- Die-cast aluminum base and sub-platter
- Base mounted display
- Stainless steel or plastic platter

### PS90:

- 150 lb / 60 Kg or 300 lb / 150 Kg capacity
- Painted steel base and sub-platter
- Display bracket with 14 ft cable where display can be base mounted or wall mounted
- Platter is typically packaged in a separate box.

---

## Optional Accessories

- Roller Top transfer platter (PS60 and PS90) used for conveyor applications that allows easy movement of package in bi-directional (right-left) motion.
- Ball Top transfer platter (PS60 and PS90) that allows easy rotation of package on the platter.
- Rail brackets (PS90) for mounting within conveyor section
- Display Options :
  - Single wall mount display with 14 ft cable, replaces the base display
  - Single tower display with 14 ft cable for counter top mounting, replaces the base display.
  - Dual wall mount displays with 6 ft cable, replaces the base display
  - Dual display tower with 10 ft cable for counter top mounting, replaces the base display
  - 2<sup>nd</sup> display, wall mounted with 10 ft Y cable. Used in conjunction with base display.
  - 2<sup>nd</sup> display, tower mounted with 10 ft Y cable. Used in conjunction with base display.
  - Display cable extension kit, 14 ft with impedance
  - RS232 extension cable, 10 ft with male / female adapters
  - 10 ft USB cable, replaces current USB cable

## Specifications

The PS shipping scale conforms to and operates best within the specifications described in this section.

## Physical Dimensions



Model	Platter	Weight (lb) and Dimensions (inches)								
		Scale					Shipping Box			
		Wt	L	W	H	D	Wt	L	W	H
PS15	Plastic	8	11.6	10.9	3.5	2	11	16	14	8
PS30	Plast, SS	12	13.9	12.3	4	2	17	19	18	10
PS60	Plast, SS	12	13.9	12.3	4	2	17	19	18	10
	Ball Top	19	13.9	12.3	5.2	2	23	19	18	10
	Roller Top	24	17	17.6	5.8	0	31	22	19	17
PS90	SS	44	20.5	16.5	4.25	2.3	53	27	22	12
	Ball Top	54	19.8	15.8	4.8	2.6	65	27	22	15
	Roller Top	53	22.8	17.5	6.1	2	63	27	22	16

Model	Platter	Weight (kg) and Dimensions (mm)								
		Scale					Shipping Box			
		Wt	L	W	H	D	Wt	L	W	H
PS15	Plastic	3.6	295	277	88.9	51	5.0	406	356	203
PS30	Plast, SS	5.5	353	312	102	51	7.7	483	457	254
PS60	Plast, SS	5.5	353	312	102	51	7.7	483	457	254
	Ball Top	8.6	353	312	132	51	10.5	483	457	254
	Roller Top	10.9	432	447	147	0	14.1	559	483	432
PS90	SS	20.0	521	419	108	58	24.1	686	559	305
	Ball Top	24.5	503	401	122	66	29.5	686	559	381
	Roller Top	24.1	579	445	155	51	28.6	686	559	406

---

## Power Requirements

The PS operates over an input voltage range of 7.5 to 14 VDC, at a current of 100 mA or less.

- For USB operation, the scale is powered through the USB port. With the low power consumption, the PS scale is within the USB power requirements for connection to your PC. Please connect scale directly to PC. Do not connect to a USB hub
- An external 9 VDC power supply is required for power to the PS scale for standalone applications or RS232 applications. The scale must be powered by the universal power supply located in the scale's shipping box. The wall mounted transformer is rated between 110-220V and 50-60 Hz. The power supply may have multiple plug adapters that can be clipped to the transformer based on available outlets.
- The power supply is not required for USB. If the power supply is connected during USB operation, the scale will automatically sense the external power supply and utilize it for the scale power.

---

## Environmental Requirements

The PS scale is designed to operate in conditions of 10-90% relative humidity, non-condensing, and a temperature range of:

- PS15: -10° to +40°C (+14° F to +104°F)
- PS30: -10° to +40°C (+14° F to +104°F)
- PS60: -10° to +40°C (+14°F to +104°F)
- PS90: -10° to +40°C (+14°F to +104°F)
- PS6L: +10° to +40°C (+14°F to +104°F)
- PS3L: -10° to +40°C (+14°F to +104°F)

The shipping and storage temperature range is -20° to +60°C (-4°F to +140°F) at 0 to 95% relative humidity, non-condensing.

The scale is designed for use in parcel shipping and other light industrial environments. This unit is not intended for dusty conditions, wash down or hazardous area operation, nor for operation in environments of extreme heat, cold, or humidity (outside of the range listed above for each model).

## Standards Compliance

- PS15: meets or exceeds USA NIST HB-44, EC and international OIML requirements for a 3000 division, Class III parcel scale.
- PS30: meets or exceeds USA NIST HB-44 for a 1400 division Class III parcel scale.
- PS60: meets or exceeds USA NIST HB-44, Australian NSC, Canadian MC, EC and international OIML requirements for a 3000 division, Class III parcel scale.
- PS3L meets or exceeds USA NIST HB-44 requirements for a 0-71b / 7-701b (1120d/5600d) Class III multi-interval scale
- PS6L meets or exceeds USA NIST HB-44 requirements for a 4800 division, Class III parcel scale.
- PS90: meets or exceed USA NIST HB-44 and Canadian MC for a 3000 division, Class III parcel scale.

The PS scales has been tested and found to comply with the limits for a Class A computing device pursuant to Subpart J of Part 15 of FCC Rules.

---

## RFI Susceptibility

The PS scale meets the requirements of the European Norm. 45501 for RFI susceptibility as listed below with a maximum of one display increment of change when calibrated for recommended builds.

Radio Interference Frequency	Field Strength
26-1000 MHz	3 volts/meter







FOR YOUR NOTES

# 2

## Installation

This chapter gives detailed instructions and important information you will need to install the PS scale successfully. Please read this chapter thoroughly before you begin installation. This information is also covered in the **PS Quick Start Guide**.

### Unpacking and Setup

The proper environment enhances the operation and longevity of the scale.

If you choose to dispose of the package, please recycle the materials. The packaging is recyclable natural fiber with biodegradable adhesives.

Please inspect the package as the carrier delivers it.

- If the shipping container is damaged, check for internal damage and file a freight claim with the carrier if necessary.
- If the container is undamaged, open the box, remove the scale, and place it on a solid, flat surface.

Please keep the packing material and shipping insert in case the scale needs to be returned to METTLER TOLEDO. The PS is a precision instrument and may be permanently damaged if not shipped in factory-approved packaging.

Open box and remove the packaging material from each side of the scale. Remove the scale by grasping the bottom sides of the scale. **Do not** lift the scale by grasping the sub-platter. Remove any protective shipping materials under the platter.

Locate a suitable environment for the scale. The scale will need to be placed on a sturdy, level surface. Refer to Chapter 1 for environmental specifications. If communication to the PC will be serial RS232, the scale will need to be located by an AC outlet for power.

### Scale Installation

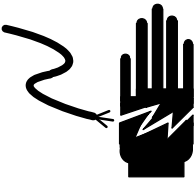
	<b>WARNING!</b>
	<p><b>AC power sources must have proper short circuit and over current protection in accordance with local and national electrical regulations. Failure to provide this may result in bodily injury and/or property damage.</b></p>

The PS shipping scale is fully assembled at the factory and ready for installation.

1. Check box for Contents. The following items should be in each package

**Typical package contents for the PS15 include:**



**Scale Base & Display**



**Platter**



**USB Cable – 6 ft**  
For USB connection to PC



**Power Supply**      **RS232 Cable – 10 ft**  
For Serial connection to PC

**Typical package contents for the PS60, 6L, 30, and 3L include:**



**Scale Base & Display**



**Platter**



**USB Cable – 6 ft**  
For USB connection to PC



**Power Supply**      **RS232 Cable – 10 ft**  
For Serial connection to PC

**Typical package contents for the PS90 include:**



**Scale Base**



**Platter**  
Packaged in separate box



**Display – Base / wall mount**  
◆ **Adhesive Pad**  
◆ **Cable – 14 ft**  
◆ **Clips**



**USB Cable – 6 ft**  
For USB connection to PC



**Power Supply**      **RS232 Cable – 10 ft**  
For Serial connection to PC

2. For the PS60, PS6L, PS30, PS3L, and PS15, go to step 3.

For the PS90, mount the display and remove the shipping tabs as instructed below:

- a) Mount display – PS90 Display can be base mounted on the scale or wall mounted. Choose one method.

**Base Mounted:** With black plastic clips in the insert position, attach display to the base by inserting the plastic clips at yellow arrows indicated below. Turn the plastic clips 90 degrees to lock into position.

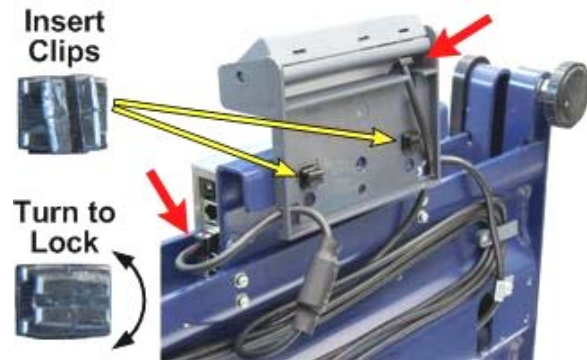

**Wall Mounted:** Remove liner on one side of the adhesive pad and insert into the display bracket. Remove liner from the other side of the adhesive pad and position the display on the wall. Display should be located on the bottom portion of the bracket. Press bracket firmly against the wall until it is secured.



Now that the display is mounted:

- o Connect display cable to the display and scale at the 2 red arrows above. Note that the cable can be inserted through guide holes in the back of the display bracket. The scale connector panel will have 4 connectors. Insert cable at connector labeled "Display". The male cable connectors have a tab. Press cable into display connector and scale connector until the tab locks into position.
  - o Wrap excess cable beneath scale. There are two grey clips on the bottom of the scale that the cable can be wrapped around.
  - o Adjust the display angle based on mounting position. Grab top and bottom of display and gently rotate up or down.
- b) Remove the four red shipping tabs on the PS90 by using a screw driver to gently pry apart the scale base until the tabs become loose. While maintaining force on the screwdriver, pull the tabs out with your fingers or needle- nose pliers. Tabs can be discarded.



3. Level the scale by turning the adjustable feet on the bottom of the unit. The scales are equipped with a level bubble. When the bubble is within the circle in the bubble indicator, the PS scale is level. The feet must be adjusted so the scale is stable and does not rock. On the PS90, tighten locking nut on feet.

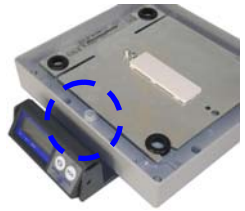

**Correct Level**  
- Bubble is completely within circle



**Incorrect Level**  
- Bubble is outside circle

4. Place Platter on the scale. The platter is held in place by compression fit with the rubber grommets on the spider



5. Confirm the connection method to the PC for communication. USB and RS232 configurations are possible. Choose one method only.



or



- USB is preferred if the Shipping / Carrier manifest system supports and designates the scale for USB set up. Consult Carrier Software documentation for details.
- USB method must be used if the scale is to communicate with multiple Shipping programs.

6. Connect Scale to PC by method chosen in step 5. Connect one method only.  
**DO NOT** connect both USB and RS232 cables. Use one or the other!

## 6a USB Connection - Preferred

- Plug small end of the USB cable into the scale connector port marked "USB".
  - For PS60, PS6L, PS30, PS3L, and PS15 turn the scale over to access the scale connector ports.
  - For the PS90, the connector port is located behind the display and slightly under the platter.
- Plug large end of USB cable into the PC. A direct connection to the computer is required. Do not use a USB Hub.
- Power Supply is not required since the low power requirements of the PS scale is adequately powered through the USB port of the computer.



**Note:** PS90, PS15 Connectors are labeled in the reverse direction

**Note:** If additional cable length is needed, a 10 ft USB cable 64057361 is available. This is a replacement cable and not an extension cable

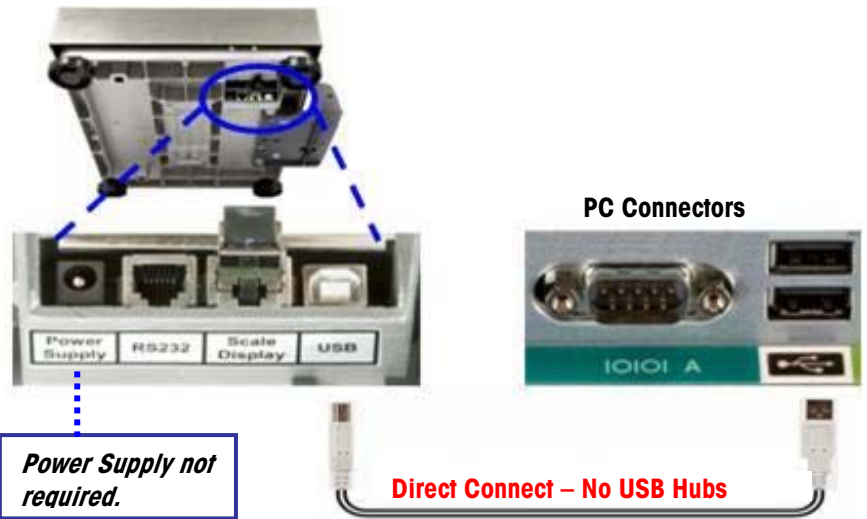

*The MT power supply can be utilized with the USB if your PC is having issues. The scale will recognize this power adapter and utilize it as the power supply instead of the USB port.*

## 6b RS232 Connection - Alternative

- Plug the small connector of the RS232 cable into the scale connector port marked "RS232".
  - For PS60, PS6L, PS30, PS3L, and PS15 turn the scale over to access the scale connector ports.
  - For the PS90, the connector port is located behind the display and slightly under the platter.
- Plug the small end of the Power Supply into the scale port marked "Power Supply"
- Go to the PC computer and locate the serial connector (typically labeled COM 1, COM A or IOIOI).
- Plug the large connector on the RS232 cable into the PC serial connector
- Plug the Power Supply into an AC outlet.

## METTLER TOLEDO PS Shipping Scale: Operator Manual

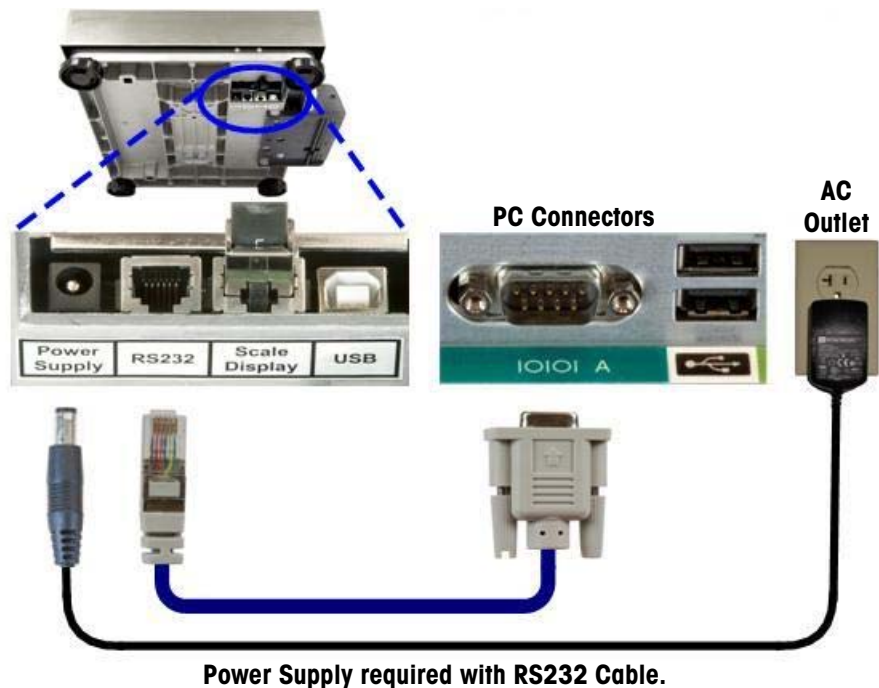

**Note:** If additional cable length is needed, a 10 ft RS232 extension cable 0900-0322-000 is available.

### Power Supply required with RS232 Cable.

*If you plugged the RS232 cable into the incorrect PC port, turn off the computer first, then change ports and reboot your computer.*

*If additional cable length is needed, see replacement parts for 10 ft. RS232 extension cable with appropriate connectors.*

*Polarity of the power supply connector jack must match the scale; Use only the Mettler Toledo Power Supply to energize the scale.*

### 7. Enter GeoCal Set up code.

The patented GEOCAL™ feature provides the best scale accuracy. The GeoCal feature precisely compensates for gravitational differences between the factory location (where the scale was calibrated) and the scale's point of use location. Since the Earth's gravity varies based on latitude and altitude, the GeoCal feature allows the PS scale to maintain the sensitive factory calibration to ensure the most accurate weighting results.

#### ★ ★ **Observe the Display on the very first power up** ★ ★



- If **0.00** is displayed than the GeoCal is not activated. No code is required. Go to step 8. For the best accuracy, scale should be calibrated on site by a trained technician with certified weights.
- If "Geo in" is displayed, than enter the two digit GeoCal Location Code for the area that the scale will be used. See the chart below for the correct code.

**Note:** If the GEOCAL™ capabilities of your PS unit have been activated, the scale will only prompt for the "Geo in" code on the first power up

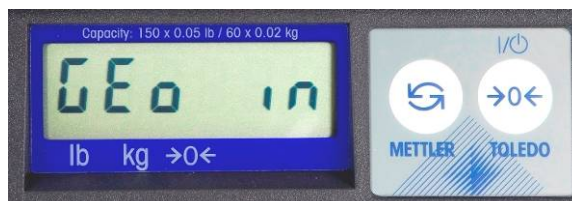
**Note:** If you missed entering the GeoCal code on the first power up, see Chapter 4 to reset the feature for the next power up.



The sequence for selecting your GEOCAL™ code is as follows:

- a) Press the ZERO key  repeatedly to scroll through the Codes. If you miss a code, keep scrolling since numbers will repeat
- b) Select the desired code by pressing the UNITS key  once. DONE will be displayed.
- c) Press the UNITS key  a second time and the scale will reboot and display 0.00.

The GeoCal process is complete and the scale has been updated for the local gravitational differences.

**Note:**

For states that have multiple listings, choose the location that is closest to you.

The GeoCal code within a state is based on latitude and is segmented between north and south directions only.

Locations near a boundary can chose either code.

GeoCal® Location Codes					
State	Code	State	Code	State	Code
<b>Alabama</b>		<b>Indiana</b>		<b>North Carolina</b>	
Birmingham & North	13	North of Indianapolis	16	Raleigh & North	14
South of Birmingham	12	Indianapolis & South	15	South of Raleigh	13
<b>Alaska</b>		<b>Iowa</b>		<b>North Dakota</b>	18
Anchorage & South	23	North of Des Moines	17	<b>Ohio</b>	
Anchorage – Kotzebue	26	Des Moines & South	16	Akron & North	16
North of Kotzebue	27	<b>Kansas</b>	14	South of Akron	15
<b>Arizona</b>		<b>Kentucky</b>	14	<b>Oklahoma</b>	13
Phoenix & North	12	<b>Louisiana</b>	12	<b>Oregon</b>	
South of Phoenix	11	<b>Maine</b>	18	Salem & North	18
<b>Arkansas</b>	13	<b>Maryland</b>	15	Salem - Oakridge	17
<b>California</b>		<b>Massachusetts</b>	17	South of Oakridge	16
North of Chico	16	<b>Michigan</b>		<b>Pennsylvania</b>	16
Chico – San Francisco	15	NW of Lake Michigan	18	<b>Rhode Island</b>	16
San Fran. - Bakersfield	14	SE of Lake Michigan	17	<b>South Carolina</b>	13
South of Bakersfield	13	<b>Minnesota</b>	18	<b>South Dakota</b>	17
<b>Colorado</b>		<b>Mississippi</b>		<b>Tennessee</b>	13
Denver & North	13	Kosciusko & North	13	<b>Texas</b>	
South of Denver	12	South of Kosciusko	12	NE of Colorado River	12
<b>Connecticut</b>	16	<b>Missouri</b>		SW of Colorado River	11
<b>Delaware</b>	15	North of Springfield	15	<b>Utah</b>	13
<b>Florida</b>		Springfield & South	14	<b>Vermont</b>	17
West Palm Beach & North	11	<b>Montana</b>		<b>Virginia</b>	14
South of West Palm Beach	10	Helena & North	18	<b>Washington, DC</b>	15
<b>Georgia</b>	12	South of Helena	17	<b>Washington State</b>	18
<b>Hawaii</b>	9	<b>Nebraska</b>	15	<b>West Virginia</b>	15
<b>Idaho</b>		<b>Nevada</b>	13	<b>Wisconsin</b>	
North of Salmon River Mt.	17	<b>New Hampshire</b>	17	Green Bay & North	18
South of Salmon River Mt.	16	<b>New Jersey</b>	16	South of Green Bay	17
<b>Illinois</b>		<b>New Mexico</b>	11	<b>Wyoming</b>	
Bloomington & North	16	<b>New York</b>		North of Casper	15
South of Bloomington	15	Albany & North	17	Casper & South	14
		South of Albany	16		

For Legal - For - Trade applications, contact your local Weights and Measure office for additional requirements and certification. See [www.ncwm.net/state](http://www.ncwm.net/state) for listing of the US Weights and Measure offices by state.



8. Configure the Carrier or Shipping software on the PC to communicate with the scale. Open your carrier or shipping software and go to the Set Up screen. Select the proper scale model from the pull down list. (Example: Toledo PS60).

For additional assistance, contact the shipping software provider.

## Installation of Accessory Items

### Remote Displays

Mettler Toledo offers several options for displays: base mounted, wall mounted, or tower mounted.

- The base mounted display has the display mounted to the scale base.
- Wall mounted displays allow the weight to be seen at eye level.
- Tower mounted display is typically used for mounting on a counter top.

**Note:** The remote displays are typically not used with the PS15 since the package size is generally small and it does not obstruct the view of the display.

The majority of scales are generally ordered with a base mounted display. Remote wall or tower displays are typically used where package size is large enough to obstruct the view of the display on the scale. For "Legal for Trade" applications, a customer display is required in most locations and remote displays are used many times for better visibility.

One or two displays can be used with each scale. Display options allow for the following:

- a) A 2nd wall mounted (0270-5X00-000) or tower mounted display (0270-7X00-000) can be added in parallel to the base display with the use of a 10 ft Y cable. To install this option:

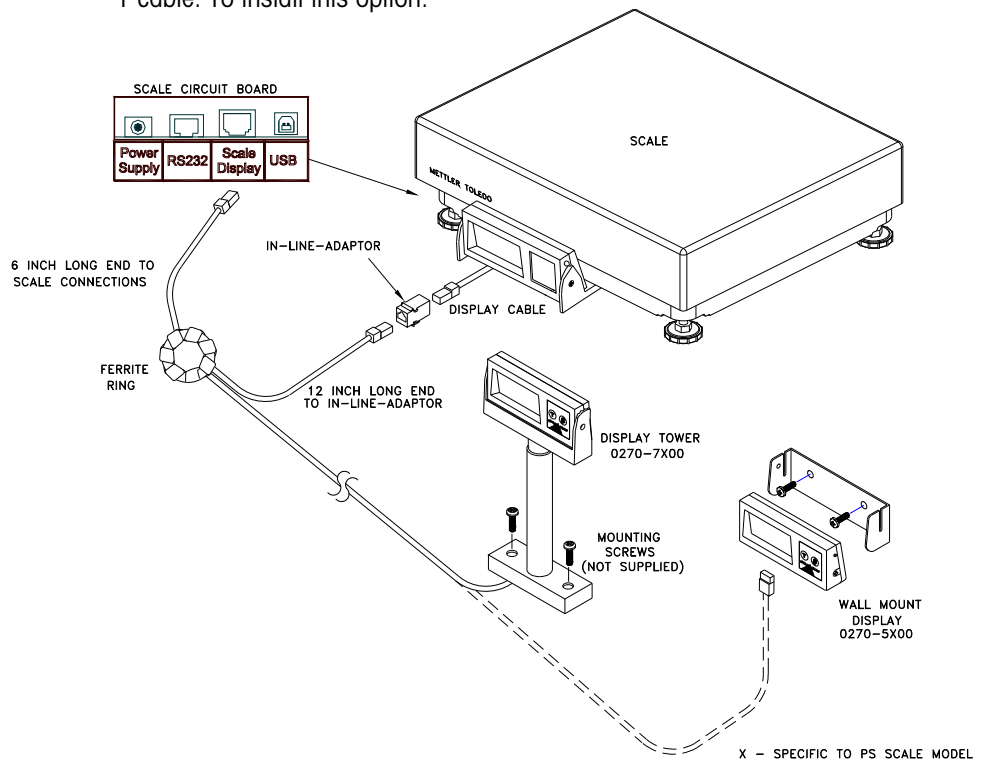

**Note:** If additional cable length is needed, a display cable extension kit 0901-0504-000 is available. Kit includes 14 ft cable and in-line adapter.

**Safety:** Make sure any excess cable is properly secured and does not provide a trip hazard for personnel or customers

- Disconnect power to the scale and locate the scale connectors: PS15, 30, 3L, 60, and 6L on bottom of scale, PS90 under the platter.
- For the connector marked "Scale display", disconnect base display cable by pressing in the latching tab on the jack while pulling the cable out. Insert the jack of the 6 inch long portion of the 10 ft "Y" cable into this same "Scale Display" connector port.
- Now connect the base display cable into one end of the In-line female-to-female adapter, and connect the 12 inch long end of the Y-cable into the other end of the In-line adapter.
- Mount remote display (Wall or Tower) in proper location with mounting screws.
- Connect the 114" long end of the Y-cable into the back side of the remote display.

- b) If the base display is **not** desired, then a single wall mounted (0270-3X00-000), or tower mounted displays (0270-2X00-000) can be substituted for the scale base display. These remote displays include a 14 ft cable.

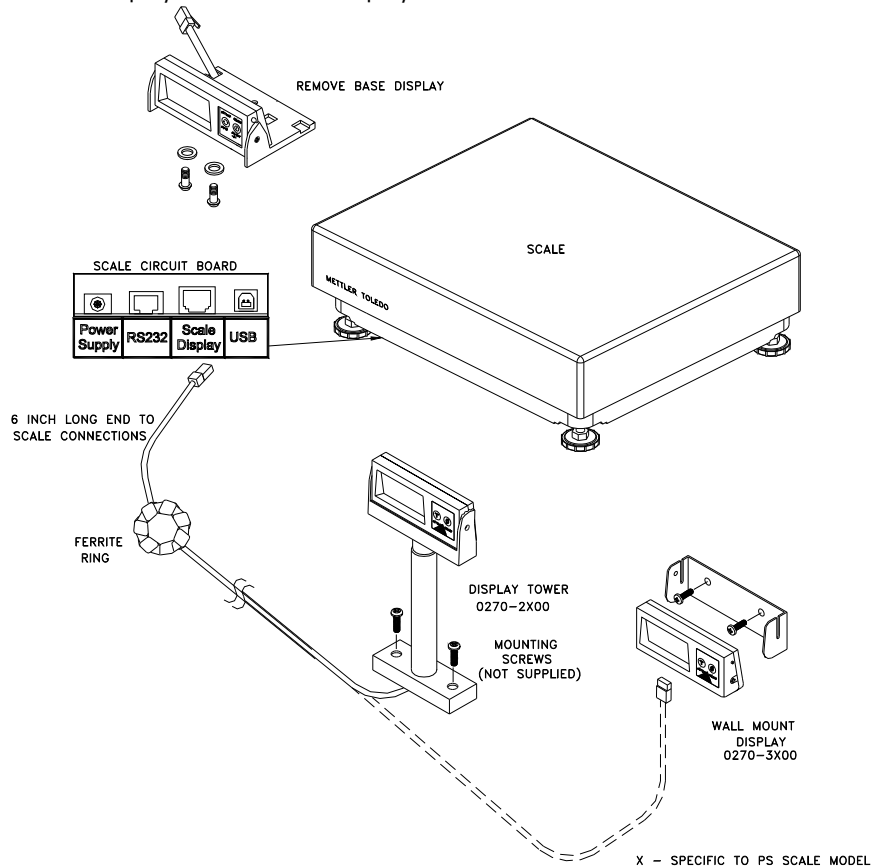

**Note:** If additional cable length is needed, a display cable extension kit 0901-0504-000 is available. Kit includes 14 ft cable and in-line adapter.

**Safety:** Make sure any excess cable is properly secured and does not provide a trip hazard for personnel or customers

- Disconnect power to the scale and locate the scale connectors: PS15, 30, 3L, 60, and 6L on bottom of scale, PS90 under the platter.
- For the connector marked "Scale display", disconnect base display cable by pressing in the latching tab on the jack while pulling the cable out. Remove the screws mounting the Base Display
- Mount remote display (Wall or Tower) in proper location with mounting screws. Connect the Display Cable into the Scale Display Jack and the remote display.

## METTLER TOLEDO PS Shipping Scale: Operator Manual

- c) If two displays are needed and the base display is not desired, then a dual wall mounted display (0270-4X00-000 with 6 ft cable), or a 2 sided tower display (0270-6X00-000 with 10 ft cable) can be substituted for the scale base display.

**Note:** If additional cable length is needed, a display cable extension kit 0901-0504-000 is available. Kit includes 14 ft cable and in-line adapter.

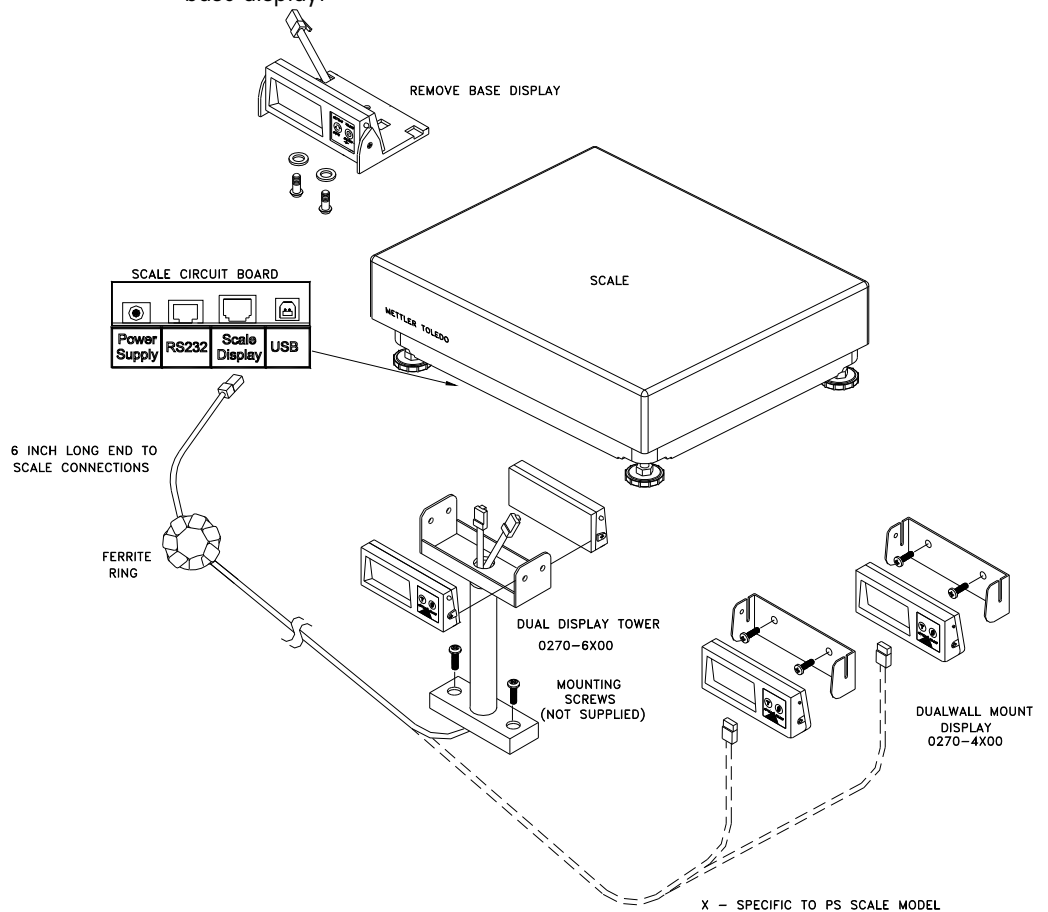

**Safety:** Make sure any excess cable is properly secured and does not provide a trip hazard for personnel or customers

- Disconnect power to the scale and locate the scale connectors: PS15, 30, 3L, 60, and 6L on bottom of scale, PS90 under the platter.
- For the connector marked "Scale display", disconnect base display cable by pressing in the latching tab on the jack while pulling the cable out. Remove the screws mounting the Base Display.
- Mount remote display (Dual Wall or Tower) in proper location with mounting screws. Connect the Display Cable into the Scale Display Jack.

---

## Installing the Ball and Roller Top Transfer Platter

A ball top or roller top transfer platter is available for the PS60 and PS90. To install the ball or roller transfer platter:

1. Remove the platter supplied with the PS. PS90 can be ordered without a platter.
2. Place the ball or roller top transfer platter on the PS scale.
3. Ensure that the ball or roller top transfer platter drops into place without mechanical interference.

Note: If the unit fails to capture zero, reboot the scale by cycling power (unplug the Wall transformer and/or USB cable). Reconnect the power source. If the scale still fails to capture zero, re-calibration will be required.

---

## Installing Conveyor Drop in Kit for PS90

For Conveyor Drop-In-Kit  
64058112:  
Reference detailed instruction set  
64058111 inside shipping box or  
obtain copy on  
[www.mt.com/ind-psscale](http://www.mt.com/ind-psscale).

The Conveyor drop in kit includes two adjustable width rail brackets that allow a PS90 scale to be integrated into a standard gravity conveyor, between 22 and 32 inches. The kit is designed for standard conveyors that use 1.9" diameter rollers on a frame that supports 1.5" spacing increments.



**WARNING! DO NOT ATTEMPT TO INSTALL THIS KIT IN A POWERED CONVEYOR.**

The PS90 scale can be mounted lengthwise or transverse in the conveyor frame for the Ball Top Platter. The ball-top platter allows packages to be rotated easily when on the scale. This option is commonly used when packages have labels that must be scanned at the shipping station.

The PS90 scale should always be mounted lengthwise when used with the roller-top platter. The roller-top platter is commonly used when packages are significantly larger than the scale.





FOR YOUR NOTES

# 3

## Operating Instructions and Maintenance

This chapter gives information that an operator will need to become familiar with the scale and perform its functions in normal operating mode. Before weighing parcels, the PS Scale should be configured properly and make sure power is applied as instructed below. How the scale operates is based on the parameter settings in the set up program. See Chap 2 for installation instructions and Chap 4 for advanced programming of the set up parameters.

### Power-up Sequence

**Note:** On most models, the I/O button is disabled and the scale is energized whenever power is applied to it, and de-energized when power is removed.

**Note:** Power supply is not needed for USB connection to a PC since the power requirements are within standard USB specifications. If the power supply is used with the USB, the scale will recognize the power adapter and use it as the power source.

**Note:** Special software version may be used for specific applications

To power up the scale, apply power to the unit:

- USB communication: Plug in USB cable to an energized PC.
- RS232 communication – Plug in power adapter to an AC outlet.

The PS goes through a power-up sequence each time power is applied. The scale performs a diagnostic test on its ROM and RAM, and then proceeds to the normal operating mode. The power-up sequence is as follows:

1. All segments of the display characters are activated. This verifies operation of all display segments.
2. The scale displays the software part number followed by the software revision status. Software numbers for the **standard** PS models are:

Model	SW Number
PS15	170700
PS30	170640
PS3L	170640
PS60	170702
PS6L	170702
PS90	174509

3. The scale then captures zero (if the zero reading is within  $\pm 10\%$  calibrated capacity on power-up) and is ready for normal operation.

To turn off the scale, unplug the power source to the scale:

- USB communication: unplug the USB cable (and power adapter if used).
- RS232 communication – unplug the power adapter from AC outlet.

## Keypad and Display

The PS scale has a simple LCD weight display with two keys that are used to perform scale functions. Keypad is used for operation of the scale as well as entering set up parameters. Weight is displayed using numeric characters with decimal point and comma. Cursors (horizontal bars) at the bottom of the display indicate current weight units, weight range, and zero condition when zero is captured.

### The Display

Cursor will indicate the weight range on Multi-Range models. Range indication is not needed with Multi-Interval models that have auto-ranging capability.

The PS scale display consists of six digits and five cursor positions. Each digit is composed of seven segments and is 12 mm high. The PS's cursor can appear above one or more of the legends printed on the display to indicate the current weight unit, weight range, a stable condition, zero, or options in setup mode.



The display area also indicates over-capacity and under-capacity conditions. Over- and under-capacity are indicated on the display as follows:





Under Capacity



Over Capacity

### Keys and Navigation

The PS keypad contains a UNITS key  and a ZERO key  :

The functions for each key **in normal operating mode** are as follows:

- **UNITS** - Press UNITS to switch between the selected primary units and alternate units.
- **ZERO** - Press ZERO to zero an empty scale.

The functions for each key **in setup mode** are as follows:

- **UNITS** - Press and hold UNITS for up to 8 seconds to enter setup mode. When a program block option is displayed for selection, press UNITS to confirm the selection.
- **ZERO** - Press ZERO to scroll through a list of parameter options.



## Operator Functions

The PS scale is simple to operate and supports one primary function: parcel weighing. With the two-key display, the operator has options for:

- Unit switching
- Zero the scale

## Parcel Weighing

You may wish to recapture zero periodically when the scale is in continuous use. It is not necessary to press ZERO before each transaction.

To weigh a package:



1. Press ZERO  to capture zero. The display reads **0.00** and a cursor appears above the zero indicator in the legend.
2. Place the parcel to be weighed on the platter. The display reads the parcel weight with a cursor above the corresponding units of weight (lb or kg).
3. Record the parcel weight as needed, then remove the parcel from the platter.

## Unit Switching

Some selections of the “build” in set up, like Multi-Interval capacities, may have unit switching inhibited. Only option presented will be “disabled”.

The PS scale lets you view the displayed scale weight in primary and secondary units. Alternate units must be enabled in setup mode (Alt in Chap 4) to convert and display in alternate units. The primary units are also designated in set up. (unitS in Chap 4)

To switch units:

1. With scale weight displayed, press the UNITS  key. The PS scale automatically converts the displayed weight to weight in the alternate unit as indicated by the cursor.
2. Press UNITS  again to switch the scale back to the primary units. The weight shown on the display will be the primary units as indicated by the cursor.

## Zeroing the Scale

Most scales are set up to re-zero if weight is within 2% of the scale capacity. If the zero change exceeds the 2% limit, the scale will not capture zero. In this case, cycle power or recalibrate.

Remove all weight and debris from the scale platter and press ZERO  to capture the zero weight. The PS display will indicate a zero reading with the cursor. The scale will re-zero provided the weight is within the designated % of the scale capacity as programmed in set up (Pb = 0 in Chap 4).

If the scale does not capture zero with the above procedure:

1. Unplug the scale, remove all weight from the platter, make sure nothing is touching the platter, and reconnect the power.
2. If cycling power does not work, recalibrate the scale per Chap 4.



## **Cleaning and Regular Maintenance**

Based on environmental conditions, you may need to wipe the keypad and platter with a clean, soft cloth that has been dampened with a mild cleaner. Do not use any type of industrial solvent such as toluene or isopropanol (IPA). These may damage the display finish. Do not spray cleaner directly onto the display terminal. Make sure no overspray hits the cable connectors or circuit board.

The PS scale is basically maintenance free. Once a year, you can verify the weight and the display readings.

- If test weights are available, place a test weight on the scale and verify the weight reading is correct. Test weight must be within the scale capacity range.
- You can check the display to ensure all segments are functioning by cycling the power to the scale. Unplug the power supply and/or the USB cable, wait a few seconds until the screen is blank, and plug the scale back in. For the first few seconds, all segments on the display will initially light up.





FOR YOUR NOTES

# TECHNICAL MANUAL

## 4

### Setup Parameters and Calibration

This chapter discusses basic information and specific instructions for configuring each program block of the PS scale, setting the operating parameters, and calibrating the PS scale.

The scale's interface program is shown in the quick overview map on the next page. There are 17 functions or programming steps available, with two levels of access:

- Normal set up parameters that can be accessed by any operator
- Full access to all set up parameters with the removal of the metrology lock (IE: calibration jumper or switch W1).

The functionality behind the Metrology lock is shown in the blue blocks on the program overview map with a Lock Symbol .

For a quick, one-selection SET UP process without calibration, the PS scale menu has a specific default setting for each of the major Shipping Carriers (FedEx, UPS, DHL NA, Purolator, etc). Go directly to the END function (Step 17) and select the default for the carrier and the scale will automatically input the other parameters. Please use one of the default settings if you do not wish to customize the parameter settings and you are not calibrating the scale with test weights.

#### Legal-for-Trade Application

Note: Accessing the calibration switch will require breaking the Weights and Measure Seal if already applied. Breaking the Weights and Measure seal will require re-certification of the scale

### Remove Cal Jumper

To access the full program, the metrology lock will need to be set to the off position by removing the Calibration jumper W1. To remove W1:

Disconnect power to the scale, remove the platter, and remove the PCB cover:

- PS60, PS30, PS3L, and PS6L – Cover is located behind the display and under the spider that holds the platter. Use 9/32 socket or adjustable wrench to remove bolt.
- PS15 – Turn scale over and remove bolt on plastic cover. Use 9/32 socket or adjustable wrench to remove bolt.
- PS90 – PCB is located under stainless steel connector cover behind the display. Remove two screws on left and right side of cover.

Inside the cover, there is a W1 (blue plastic) jumper indicated by the red dashed circle in photo. Remove jumper off of both prongs and replace jumper on only one prong so it doesn't get lost.

Replace cover loosely and place platter back on the scale. Connect the power source to the scale.

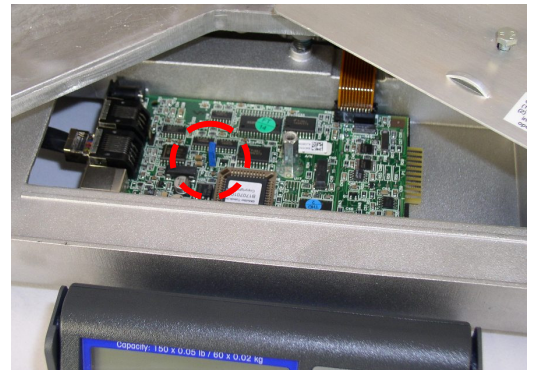

# PS Scale Program Menu

**Program Step**

**Category**

**Display**

**Parameter listing**

Press and Hold Units Key for 8 Sec to enter setup mode

**Metrology Lock**

- Remove PCB Cover on top of scale (Bottom for PS15)
- Remove Blue W1 jumper on PCB to access functionality



Units Key

Zero Key

**nodE** Note: 7 Segment Display is limited in alpha characters that can be displayed (IE: No Letter "M" so "n" is used)

Not available on all models or builds (IE: Multi-Interval)

1 Set Range of Zero button - % Capacity

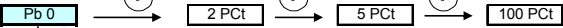

2 Display indicator for Center of Zero

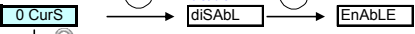

3 Units at Power up

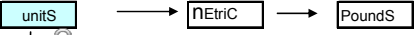

4 Set Capacity and Increments



Scale	Units	Build Options - based on "Units" selected and PS Model							
		1	2	3	4	5	6	7	8
PS15	Pounds	30-01	30-005	30-n0					
	Metric(kg)	15-005	15-002	15-ni	15-nC				
PS30	Pounds	70-05	70-nr	70-ni	70-n0				
	Metric(kg)	30-02	30-01	30-ni					
PS60U	Pounds	150-02	150-05	100-n0	100-05	150-ni	149-ni	150-n5	100-ni
	PS6L	Metric(kg)	60-01	60-02	45-05	45-02	60-ni	70-ni	60-nC
PS90U	Pounds	150-05	250-1	300-1		149-ni	200-ni		
	Metric(kg)	60-02	100-05	150-05	150-nC	60-05	90-1		

5 Alternate Unit Switching - kg/lb

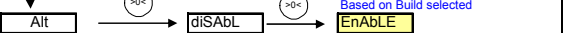

6 Weight Mode



7 Vibration Filter

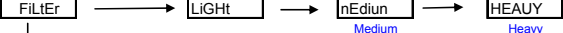

8 Baud Rate

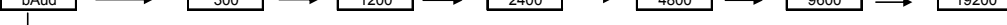

8 Select # Data Bits ASCII Characters

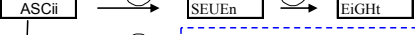

10 Parity Bit

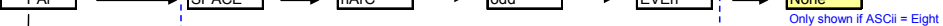

11 # of Stop Bits

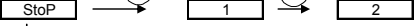

12 Protocol



13 Power Saving mode

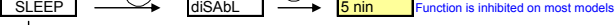

14 GeoCal



15 Select Cal weights

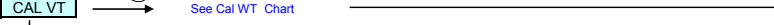

Scale	Units	Calibration Weight Options			
		Cal 1	Cal 2	Cal 3	Cal 4
PS15	Pounds-lb	5	10	15	20
	Metric-kg	2	5	7	10
PS30	Pounds-lb	5	25	30	50
	Metric-kg	2	10	15	20
PS60U	Pounds-lb	25	50	75	100
	PS6L	Metric-kg	10	20	30
PS90U	Pounds-lb	25	50	70	100
	Metric-kg	10	20	25	45

16 Calibration Mode



Empty Any previous Set Up changes are now saved

Add X WT

Done Scale will exit Set Up mode, reboot and go to GeoCal if enabled

17 Exit Setup select Defaults

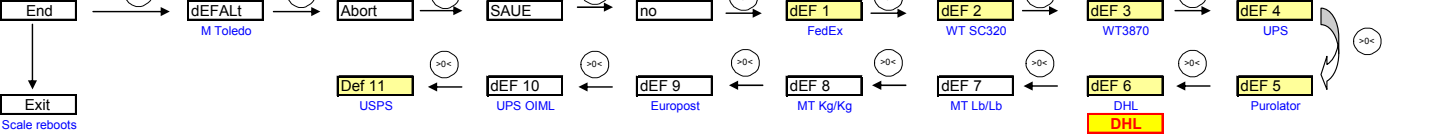

Use to Customize Serial set up

Scale reboots

## Configuring Setup Parameters

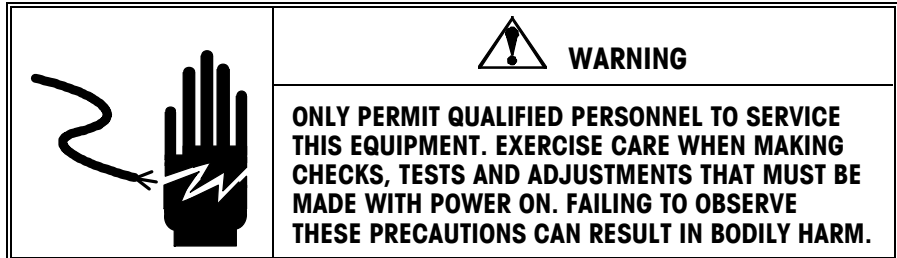

Program Menu chart

**Units Key** - will accept the value and scroll vertically to the next step.

**Zero key** - will move horizontally to the next parameter value.

To enter the setup mode, press and hold the UNITS key  for up to eight seconds until the message **Setup** is displayed. Release the UNITS key, and the first function (PB 0) will be displayed.

To program the scale, use the two function keys as follows:



To exit the set up program early:

First Method

- o Press the UNITS key repeatedly until End is displayed.
- o Press the ZERO key until SAVE or Abort is shown.
- o Press the UNITS key to accept

Second method

Disconnect the power from the scale. Changes **will not** be saved.

 **Units Key** - will accept the current displayed parameter value and increment to the next function (IE: program block or Step).

 **Zero Key** - will scroll through the available parameters for a specified function, (IE: program block or Step).

This section describes the program blocks that govern normal operation including:

Pb 0	Push Button Zero Range*	PAR	Parity –RS232
0 CurS	Zero Cursor (indicator bar) *	StoP	Stop Bits – RS232
units	Units displayed at Power-up *	Proto	Comm. Protocol –RS232
buiLd	Build (Capacity/Increment)*	SLEEP	Sleep
ALt	Alternate Units (Switching)	Geo in	GeoCal™ *
nodE	Mode *	CAL V	Cal Weight used*
FiLTeR	Filter	CAL	Calibration *
bAud	Baud Rate – RS232	End	End
AScii	ASCII – RS232		

The 7 segment display is limited on the Alpha characters that can be displayed, (IE: no "m" can be displayed so letter "n" is used instead.

\* Items are locked by the Calibration Jumper W1 

The PS scale can also be configured remotely through the METTLER TOLEDO Host Interface. Details for configuring the scale using the Host Interface are given in the Appendix at the end of this manual.

As stated above, the PS scale can be

1. **Customized** by going through the menu and selecting each parameter
2. **Default** selection - the PS scale also has a quick, one-selection SET UP process for each of the major carriers through the default selection in the End program block (Step 17). Use a default selection if you do not wish to customize the parameter settings. The default selection will automatically enter the other parameters.

**To select a default setting;**

- ◆ Press the UNITS key repeatedly until End appears on the screen
- ◆ Press the ZERO key repeatedly until the proper default selection is shown.
  - **Default** – Mettler Toledo
  - **Def 1** – FedEx
  - **Def 2** – WT SC320
  - **Def 3** – WT SC3870
  - **Def 4** – UPS
  - **Def 5** – Purolator
  - **Def 6** – DHL / Airborne
  - **Def 7** – MT for lb/lb
  - **Def 8** – MT for kg/kg
  - **Def 9** – Euro post
  - **Def 10** – UPS OIML
  - **Def 11** – USPS
- ◆ Press the Units key again to accept the Default selection. Scale will update the parameters and reboot.

**To customize the parameter settings or to calibrate the scale:**

- ◆ Continue with the setup process below.

Not all default selections may be available. Default selection is based on the model ordered or "Build" selected below.

---

## Push Button Zero

The 100% zero range can be used as a tare function.

The Push Button Zero program block lets you configure the range the  key can be used to capture zero. The ranges currently supported are  $\pm 2\%$ ,  $\pm 5\%$ , and  $\pm 100\%$  of capacity (Metrology PCB jumper must be removed). This range does not affect the zero range when the scale is powered up.

To configure the program block:

1. Press UNITS to display the **Pb 0** prompt, then press ZERO to access the options.
2. Press ZERO repeatedly until the desired zero capture range is displayed.
3. Press UNITS again to accept the pct option. The PS continues to the Zero Cursor program block.

---

## Zero Cursor

The Zero Cursor program block lets you enable or disable the center of zero indicator on the PS display. (Metrology PCB jumper must be removed.)

To configure the program block:

1. Press UNITS to display the **0 CurS** prompt, then press ZERO.
2. Press ZERO to display the desired approval setting, enable or disable.
3. Press UNITS to accept the displayed option. The PS continues to the Power-up Unit program block.

## Units at Power-up

The Power up Unit program block lets you select the scales primary unit of weight, which would be the weight unit active when the scale is powered up. This program block will effect the build options that are seen in the Build program block.

To configure the program block:

1. Press UNITS to display the **unitS** prompt, then press ZERO.
2. Press ZERO to display the desired approval setting, pounds or metric.
3. Press UNITS to accept the displayed option. The PS continues to the Build / Alternate Units program block.

## Build Program Block

The build program block lets you chose a capacity and increment size setting for the product based on the model you have purchased and the power-up units selection. (Metrology PCB jumper must be removed.)

To configure the program block:

1. Press UNITS to display the **builD** prompt, then press ZERO.
2. Press ZERO to display the desired approval setting. Options are dependent on the **unitS** selected above and may vary as follows:

Power-up units	Model	Option	Display	Range	Unit Switch	Capacity and Resolution
Pounds (lb)	PS15	1	30-01	S	Yes	30 x 0.01 lb
		2	30-005	S	Yes	30 x 0.005 lb
		3	30-no	MI	No	0-15lb x 0.1 oz / 15-30 lb x 0.2 oz. .
	PS30 PS3L	1	70-05	S	Yes	70 x 0.05 lb
		2	70-nr	MR	No	0-7 x 0.005 / 7-70 x 0.02 lb
		3	70-ni	MI	No	0-7 x 0.01 / 7-70 x 0.02 lb
		4	70-no	MI	No	0-7lb x 0.1 oz / 7-70 lb x 0.2 oz. .
	PS60 PS6L	1	150-02	S	Yes	150 x 0.02 lb
		2	150-05	S	Yes	150 x 0.05 lb
		3	100-no	MI	Yes	0-10 lb x 0.01oz / 10-100 x 0.5 oz
		4	100-05	S	Yes	100 x 0.05 lb
		5	150-ni	MI	No	0-60 x 0.02 lb / 60-150 x 0.05 lb
		6	149-ni	MI	No	0-10 lb. x 0.1 oz, 10-70 lb. x 0.2 oz, 70-150 lb. x 0.5 oz
		7	150-n5	MI	No	0-5 x 0.005 / 5-25 x 0.05 / 25-150 x 0.1 lb
		8	100-ni	MR	Yes	0-10 lb x 0.01oz / 10-20 lb x 0.2 oz / 20-40 lb x 0.5 oz / 40-100 x 1 oz
	PS90	1	150-05	S	Yes	150 x 0.05 lb
		2	250-1	S	Yes	250 x 0.1 lb
		3	300-1	S	Yes	300 x 0.1 lb
		4				
		5	149-ni	MR	NA	0-50 lb. x 0.5 oz, / 50-149 lb. x 2 oz,
		6	200-ni	MR	NA	0-50 lb. x 1 oz, / 50-200 lb. x 2 oz,



Power-up units	Model	Option	Display	Range	Unit Switch	Capacity and Resolution
Metric (kg)	PS15	1	15-005	S	Yes	15 x 0.005 kg
		2	15-002	S	Yes	15 x 0.002 kg
		3	15-ni	MI	No	0-3 x 0.001 / 3-15 x 0.005 kg,
		4	15-nC	S	No	15 x 0.005 kg
	PS30 PS3L	1	30-02	S	Yes	30 x 0.02 kg
		2	30-01	S	No	30 x 0.01 kg
		3	30-ni	MI	No	0-15 x 0.005kg / 15-30 x 0.01 kg
	PS60 PS6L	1	60-01	S	Yes	60 x 0.01 kg
		2	60-02	S	Yes	60 x 0.02 kg
		3	45-05	S	Yes	45 x 0.05 kg
		4	45-02	S	Yes	45 x 0.02 kg
		5	60-ni	MI	No	0-30 x 0.01kg / 30-60 x 0.02 kg
		6	70-ni	MI	No	0-50 x 0.02kg / 50-70 x 0.05 kg
		7	60-nC	S	No	60 x 0.02 kg,
		8	45-ni	S	Yes	0-45 x 0.05kg
	PS90	1	60-02	S	Yes	60 x 0.02 kg
		2	100-05	S	Yes	100 x 0.05 kg
		3	150-05	S	Yes	150 x 0.05 kg
		4	150-nC	S	No	150 x 0.05 kg,
		5	60-05	S	Yes	60 x 0.05 kg
		6	90-1	S	Yes	90 x 0.01 kg

- Range: S = Single Range, MR = Multi-Range, and MI = Multi-Interval with the auto ranging ability.
- Unit Switch: **Yes** means that unit switching is permitted and can be set in the **Alt** program block below. **No** means unit switching is inhibited. Resolution and increment size of the alternate units will be the same option number for that PS scale model. PS60 in pounds with option 5 of 100-05 build will have the capacity of 45 kg and 0.02 kg resolution when switching to metric units.

3. Press UNITS to accept the displayed option. The PS continues to the Alternate Units program block.

Note: the scale can only be sealed for Weights and Measure in the build that is listed on the data label. The PS6L and PS60 have the same listing on the display for the selection of the capacity and increment size, but utilize different load cells.

## Alternate Units

**Note:** Resolution and increment size of the alternate units will be the same option number for that PS scale model.

This program block lets you enable or disable unit switching during normal operation. Unit switching must be permitted in the **buILD** selection above.

To configure the program block:

1. Press UNITS to display the **Alt** prompt, then press ZERO.
2. Press ZERO to display the desired approval setting, enable or disable.
3. Press UNITS to accept the displayed option. The PS continues to the Mode / Filter program block.

---

## Mode Program Block

If Test mode is accidentally selected, scale will display **dLC** and stay in that mode. To exit, remove power from the scale, install Cal jumper, and power up scale.

The Mode program block lets you configure which mode is used to display weight. (Metrology PCB jumper must be removed.)

To configure the program block:

1. Press UNITS to display the **nodE** prompt, then press ZERO.
2. Press ZERO to display the desired mode. Options include:
  - Test – Used for manufacturing only.
  - Normal – Retail rounding: round up for values of 5+
  - Expanded – view expanded weight, typically view 10X resolution
  - Classifier – weight classifier rounding: round up for values 1+
  - USPS – USPS rounding for PS30 only
3. Press UNITS to accept the displayed mode option. The PS continues to the Filter program block.

---

## Filter Program Block

Heavier filter settings increase the time required for the scale to settle on a stable weight.

The Filter program block lets you configure the vibration noise filter that is used in determining weight stability on the scale. The PS disregards environmental vibrations that affect the weighing accuracy according to the filter setting.

To configure the program block:

1. Press UNITS to display the **FILtEr** prompt, then press ZERO.
2. Press ZERO to display the desired noise filter. Options include:
  - Light
  - Heavy
  - Medium
3. Press UNITS to accept the displayed filter option. The PS continues to the Baud program block.

---

## Baud Program Block

This program block lets you set the baud rate for RS232 connection (the speed at which data is transmitted in bits-per-second).

To configure the program block:

1. Press UNITS to display the **bAud** prompt, then press ZERO.
2. Press ZERO to display the desired baud rate. Options include:
 

• 300	• 4800
• 1200	• 9600
• 2400	• 19200
3. Press UNITS to accept the displayed baud rate option. The PS continues to the ASCII program block.

---

## ASCII Program Block

The ASCII program block lets you select the number of data bits that make up an ASCII character for RS232 connection. Most METTLER TOLEDO equipment communicates using seven data bits.

To configure the program block:

1. Press UNITS to display the **ASCii** prompt, then press ZERO.
2. Press ZERO to display the desired bit selection. Options include:
  - Seven (7)
  - Eight (8)
3. Press UNITS to accept the displayed option. The PS continues to the Parity program block.

---

## Parity Program Block

Based on ASCII setting:

- ASCII = 7, options are Space, Mark, Odd, and Even.
- ASCII = 8, options are None

The Parity program block lets you select the parity option for data transmission for RS232 connection. Parity is an error checking mechanism. To configure the program block:

1. Press UNITS to display the **PAR** prompt, then press ZERO.
2. Press ZERO to display the desired parity option. Options include:
  - Space
  - Even
  - Mark
  - None (Only if ASCII = 8)
  - Odd
3. Press UNITS to accept the parity option. The PS continues to the Stop program block

---

## Stop Bit Program Block

The Stop Bit program block lets you select the number of stop bits to be transmitted for each ASCII character for RS232 connection. Most METTLER TOLEDO products will work with either 1 or 2 stop bits.

To configure the program block:

1. Press UNITS to display the **StoP** prompt, then press ZERO.
2. Press ZERO to display 1 or 2 stop bits, then press UNITS to accept the displayed selection. The PS continues to the Protocol program block.

---

## Protocol Program Block

The Protocol program block lets you select a pre-configured set of scale commands for RS232 connection. Protocols are configured in the factory according to your ordering information. This section gives instructions on how to select a protocol only.

To select a protocol command set:

1. Press UNITS to display the **Proto** prompt, then press ZERO.
2. Press ZERO to display the desired protocol. Options include:
  - Toledo (Mettler Toledo)

Proto1 through Proto 6 are not available for lb-oz builds.

- Proto 1 (Fed Ex )
  - Proto 2 (Weightronix SC-320)
  - Proto 3 (Weightronix 3870 )
  - Proto 4 (UPS)
  - Proto 5 (Purolator)
  - Proto 6 (Airborne/DHL)
  - Proto 7 (SICS)
  - Disable(turns off communications)
3. Press UNITS to accept the protocol option. The PS continues to the Sleep program block.

---

## Sleep Program Block

Sleep timer is currently not used and will only display "Disabled" status.

---

## GeoCal™ Program Block

After the Geo Cal value has been entered on the next power up, the "GEo in" program block will revert back to disabled.

This program block lets you enable the GeoCal™ prompt at power-up. If this setting is enabled, the unit will prompt for the entry of a GeoCal™ code on the first power up after setup is exited. Prompting for the GeoCal code is a one shot function

To configure the program block:

1. Press UNITS to display the **GEo in** prompt, then press ZERO.
2. Press ZERO to display the desired setting, enable or disable.
3. Press UNITS to accept the displayed option. The PS continues to the Cal program block.

If the GeoCal is enabled, reference Chapter 2 for detailed information about inputting the GeoCal™ code on the next power up. After the GeoCal value is entered, the scale will not prompt for the Geo code number on subsequent power ups.

---

## Calibration Weight

Displayed weight options are based on PS model and parameter selected for the Units.

This program block lets you designate the calibration weight amount that will be used to calibrate the scale. (Metrology PCB jumper must be removed.)

Scale	Units	Calibration Weight Options			
		Cal 1	Cal 2	Cal 3	Cal 4
PS15	Pounds-lb	5	10	15	20
	Metric-kg	2	5	7	10
PS30 PS3L	Pounds-lb	5	25	30	50
	Metric-kg	2	10	15	20
PS60U PS6L	Pounds-lb	25	50	75	100
	Metric-kg	10	20	30	45
PS90U	Pounds-lb	25	50	70	100
	Metric-kg	10	20	25	45

---

## Calibration Program Block

**Note:** If you have not gone through the previous steps in this chapter, Cal is only displayed when the W1 Jumper is removed from the PCB and the scale is in the set up mode.

- See first page of this chapter to remove W1
- To access the set up mode, press the UNITS key for 8-10 secs.

**Note:** If the calibration sequence is the end of the programming process, re-install Cal jumper when completed.

- Disconnect power to the scale
- Remove platter and PCB cover
- Re-install calibration switch (W1 jumper)
- Install cover and platter
- Power up scale.

This program block lets you calibrate the scale with the appropriate test weights selected above. (Metrology PCB jumper must be removed per the first page of this chapter.)

### To calibrate the scale:

1. If **Cal** is not displayed, press the UNITS key to display the **Cal** prompt, then press ZERO to display YES or NO. Select "Yes" to calibrate or select "No" to abort or bypass calibration.
  - If "No" is displayed, press the UNITS key to accept. The PS continues to the End program block. Skip the rest of the Calibration steps below.
  - If "Yes" is displayed, press UNITS to begin the calibration process. Go to step 2 below. Any changes to the above set up parameters will be saved at this time. After the completing the calibration sequence below, the scale will automatically save the calibration data, exit setup mode, and reboot the scale. The End program block will not be displayed after calibrating the scale.
2. At the **Empty** prompt, insure that the platter is on the sub-platter, there is no weight or debris on the platter, and there is nothing touching the platter. Once the above items are confirmed, then press UNITS key.
3. At the **Add XX** prompt the unit is indicating how much weight should be placed on the platter as selected in the Calibration Weight function above. A cursor appears over either lb or kg on the lens to indicate which units are required. Place the appropriate weight on the platter, then press UNITS. The scale automatically determines a span factor then indicates **Done** while the calibration values are saved.
4. Remove the calibration weight from the scale platter and press the UNITS key again. The scale will power down and all parameter selections made in previous program blocks will be saved. Scale will automatically restart . It will no longer be in Set Up mode.
5. When the scale powers back up, check the accuracy of the scale. Verify zero and span using the test weights. Place the test weight at multiple locations on the platter.

The PS scale is now calibrated. If desired, re-install Calibration jumper if no more programming is to be done. See section below on how to seal the scale for Legal for Trade applications.

---

## End Program Block

The End program block lets you save the configuration and exit setup mode. The END The program block also contains the quick, one selection set up process for each of the carriers (FedEx, UPS, DHL NA, Purolator, etc) by selecting the appropriate default setting.

To use the End program block:

1. Press UNITS to display the **End** prompt.
2. Press ZERO to display the desired exit option. Exit options include:
  - **Default**—Reset all program block parameters to standard MT values, then exit setup mode. (Standard for FedEx Ground and DHL)
  - **Abort**—Exit setup mode but do not save any changes made in this session.
  - **Save**—Exit setup mode and save changes made in this session.
  - **Def 1** – FedEx
  - **Def 2** – WT SC320
  - **Def 3** – WT SC3870
  - **Def 4** – UPS
  - **Def 5** – Purolator
  - **Def 6** – DHL / Airborne
  - **Def 7** – MT for lb/lb
  - **Def 8** – MT for kg/kg
  - **Def 9** – Euro post
  - **Def 10** – UPS OIML
  - **Def 11** – USPS

**Note:**

- Def 11 only on PS3L
- Def 1 thru 6 not on lb-oz builds (IE: PS3L and PS6L )

Choosing a default, rather than selecting SAVE, will automatically set the following program blocks:

- |                    |                |
|--------------------|----------------|
| • Zero Cursor      | • PARITY       |
| • Power-up Units   | • STOP BITS    |
| • Units Switching  | • Sleep Mode   |
| • Filter           | • Protocol     |
| • BAUD             | • Display Mode |
| • ASCII BIT String |                |

3. Press UNITS to carry out the displayed option.
4. If the Calibration jumper was removed, replace jumper.
  - Disconnect power to the scale
  - Remove platter and PCB cover
  - Re-install calibration switch (W1 jumper)
  - Install cover and platter
  - Power up scale.

## Metrological Seal Installation

If a wire seal is required for W & M requirements, the PS can be sealed after calibration and setup by installing a wire seal on the Main PCB access cover

- ◆ **PS15** - Loop wire through holding screw for PCB cover and holes in the plastic cover
- ◆ **PS60, 6L, 30, and 3L** - Loop wire through holding screw for PCB cover and domed handle on the cover

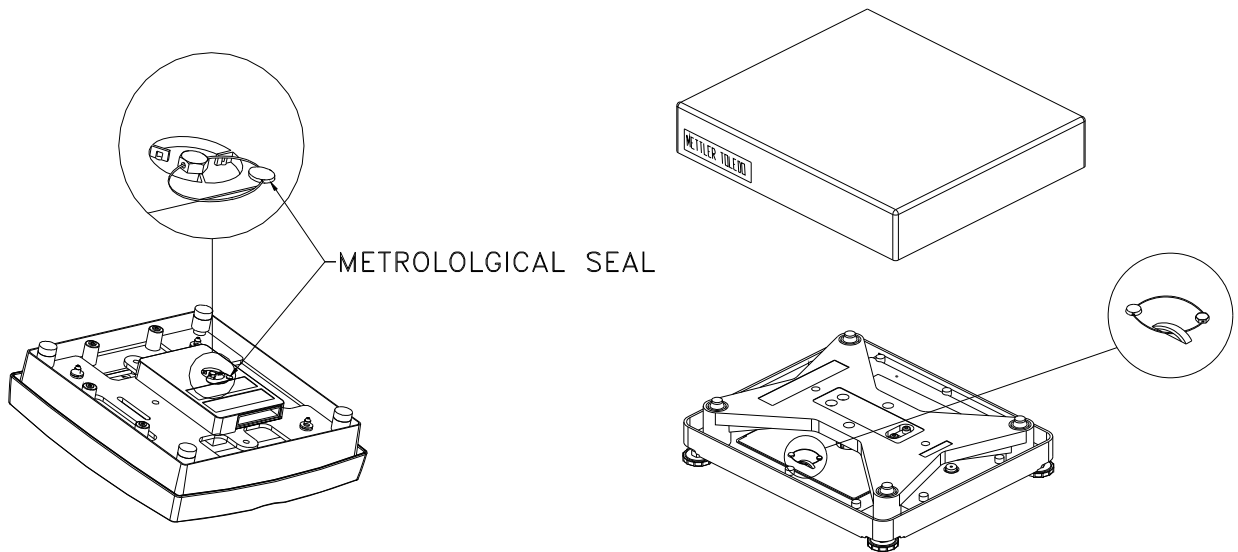

- ◆ **PS90** - install a wire seal through the screw of the PCB cover and the access hole on the base plate. There are two sides to be sealed on the PS90. Alternatively, install a tamper evident label on each end of the Main PCB access cover. See photo and drawing below.

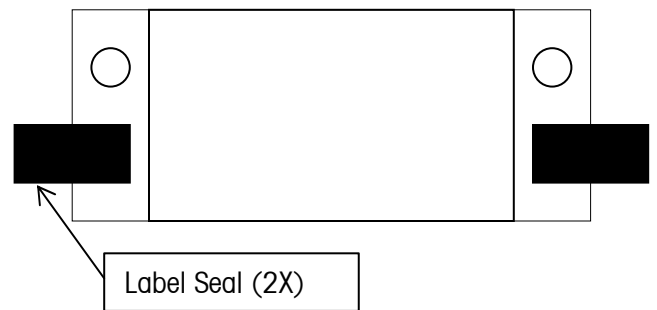







FOR YOUR NOTES

# 5

## Service and Repair

This chapter gives information on servicing, upgrading, and maintaining the PS scale including troubleshooting, and replacement of key components.

### Troubleshooting

The PS shipping scale is designed to be virtually error free and reliable. If problems do occur, do not attempt to repair the scale before you have determined the source of the problem. Record as much information as possible about what has happened including any messages and physical responses. The following troubleshooting information may help to determine the cause of the problem.

	<b>WARNING!</b>
	<b>Always remove all power before servicing any equipment. Mettler-Toledo recommends that only qualified technicians open the unit up for maintenance and repair. If you must open the PS scale, read this section carefully to avoid damage to the internal components.</b>

## Error Code Section

Error codes are displayed on the weight indicator with a leading "E" to distinguish themselves from weight data.

<b>Code</b>	<b>Meaning</b>	<b>Action</b>
E1	ROM (checksum) error	Replace the circuit board to clear this error (call Mettler Toledo Service)
E2	RAM error	Replace the circuit board to clear this error (call Mettler Toledo Service)
E3	EEPROM error	<p>Setup and /or calibration information does not match EEPROM requirements. Press any display button and the scale will enter setup mode or calibration mode depending on what information requires updating.</p> <p>If both setup and calibration information has been lost, the scale will enter setup mode first when a display button is pressed. After completing the setup, the scale will display E3 again until a button is pressed to enter calibration mode and calibration is completed.</p> <p>Reset the setup parameters and/or recalibrate to clear this error. If the scale continues to display E3 after the setup and/or calibration has been completed, the load cell is unable to save the information and will need to be replaced (call Mettler Toledo Service)</p>
E4	TC error	Load cell harness not properly connected, or load cell not communicating to circuit board. Check harness connection. If error persists, replace the load cell to clear this error (call Mettler Toledo Service)
E5	Serial Communications (Data) error	The scale has received a character from the host with an invalid parity. The scale will display E5 until either a display button is pressed or another character is received. This error could be caused by an incorrect Baud Rate or Data Bits (ASCII parameter) selection in the scale setup. Confirm selection of the set up parameters.

## Check Wall Transformer

Contact Mettler Toledo for correct part number of power adapter. Using the wrong type of adapter may damage the scale

For USB Communication: Does not require the power supply.

For RS232 communication: the power supply or wall transformer can be checked for proper voltage with an electrical multi-meter by a trained technician. The center conductor of the power supply is positive. Connect power supply to AC outlet and do not connect to the scale. Set meter for DC voltage and check the voltage level by inserting the positive probe in the center of the jack and the negative probe on the outside of the jack .

When disconnected from the scale, the voltage on the power supply should be close to 9 VDC. If the voltage on the universal power supply does not read within the range of 8.5 VDC to 9.5 VDC, replace the wall transformer.

Alternate Method: Check to see if scale can be energized by USB connection.

- Disconnect power supply from AC outlet. Disconnect RS232 cable from the scale.
- Re-connect scale by USB method to PC. Plug small end of USB cable (USB B connector) to the scale and large end (USB A connector) into a PC. A direct connection to the PC is required. Do not use an USB hub.
- If scale display is energized with the USB cable connected than the power supply or power supply connector is bad.

---

## Blank Display

The I/O function on the keypad is disabled in most models. Cycle the power by unplugging the scale from its power source.

Scale is not receiving power or the display cable is not attached to the scale base properly.

- For RS232, confirm power supply is plugged into working AC outlet and power supply is plugged properly into scale base.
- If using USB, make sure USB cable is pushed in all the way at both the scale and the PC.
- If you have verified that the scale is receiving power, and you still have nothing on the display, then check the display cable at the connectors. Unplug display by pushing in on the connector tab and pulling back on the cable. Reinsert the display cable into the scale connector making sure the tab clicks into position.

If the blank display continues, replace the O270 Display.

---

## No Keypad Interaction

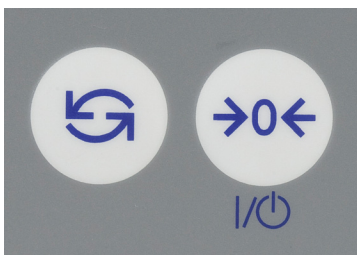

The UNITS key may be disabled in operation depending on the model or capacity and increment size selected in the Build parameter in setup. For these models, the UNITS key will still function in the set up mode. The I/O function for the zero key is disabled on most models.

To test the operation of the keypad, remove power, then reapply. With power to the unit, attempt to enter setup mode by pressing and holding the UNITS key (IE: 8-10 sec). If the display does not indicate setup mode, replace the O270 Display.

---

## Indicator Locked

To test operation of the indicator, remove power, then reapply. With power to the unit and display reading zero, add weight. If no change in weight is displayed, replace either the load cell or the Logic PCB.

## Serial Communication Test with PC

**Note:** Test does not apply if using USB communications.

A HyperTerminal serial (RS232) test can be conducted to see if serial communication problems are occurring. This test can determine if the issue is with the scale connection / communication to the PC, or if the issue is within the Shipping software program itself.

The HyperTerminal test will confirm

- If the scale is properly connected to the PC
- If the scale is able to communicate by serial RS232 to the PC
- If the scale is able to display the correct weight

Run this test whenever it is unknown as to why the manifest or shipping software is not showing a weight, or the proper weight, on the PC screen.

1. Connect Scale to the PC as shown below. Note the COM port on the PC that the scale is connected to for step 5.

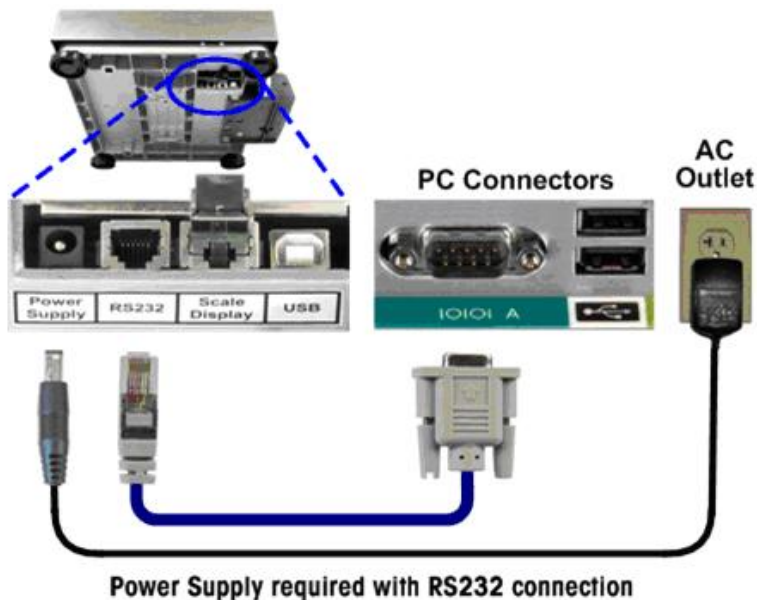

2. After Scale Powers up, enter GeoCal value if "Geo in" is displayed. See Quick Start Guide for Geo Location Codes and how to enter the value.
3. Check the scale's serial set up parameters per steps in chap 4. Write down the values for BAud, ASCii, PAr, StoP and Proto as you will need to enter the matching data in the HyperTerminal screen.
4. Access the HyperTerminal program on your PC as shown below. HyperTerminal is a standard Windows program (XP operating system shown below).

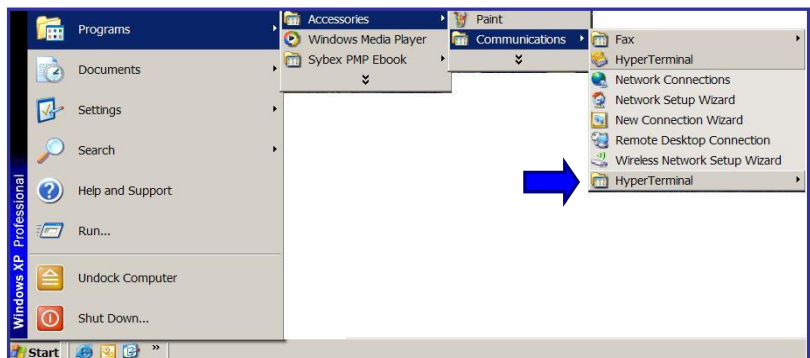

- 5. Once HyperTerminal is opened, choose "File" than "New Connection". Name the connection "PS Scale" for future reference and click "OK". Click on the drop down bar for "Connect Using". Select the communication port that the scale cable is connected to on the PC. COM A would be equivalent to COM 1. Click "OK" when completed.

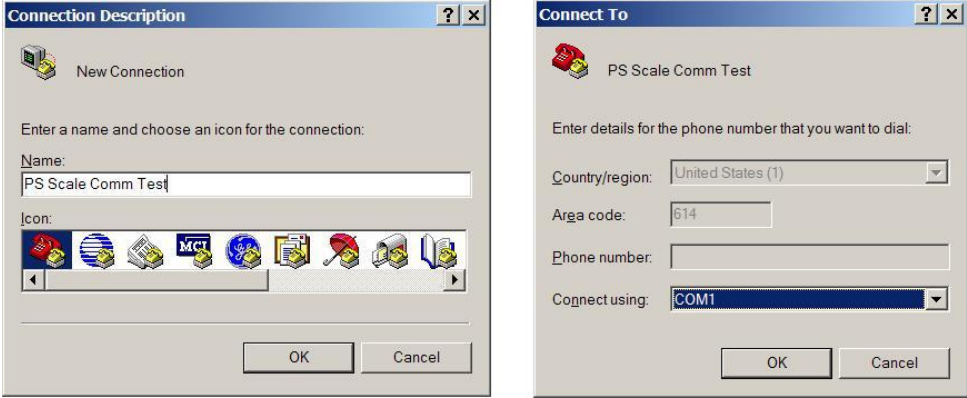

- 6. Program the same set up parameters in HyperTerminal as per the Baud, ASCII, Par and Stop settings in the scale. For the Flow Control setting, input "None". Scale does not use this parameter.

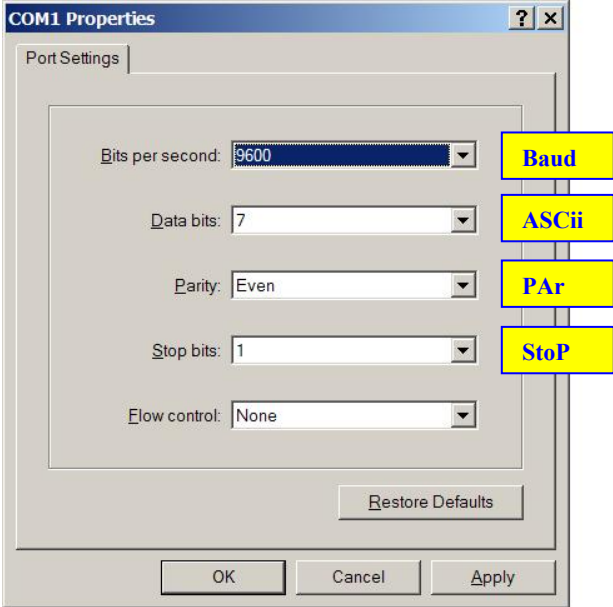

Click Apply after entering the data values. The data will be accepted. Click OK and a blank HyperTerminal screen will appear.

## METTLER TOLEDO PS Shipping Scale: Technical Manual

**Note:** It is important to initially click the cursor on the blank screen.

**Note:** <CR> is carriage return or Enter



**Note:** To see the character you typed (IE:W), go to FILE – PROPERTIES – SETTING tab – ASCII SETUP box, and click “Echo typed characters locally”. For MT SIC Proto, also click “Send line ends with line feeds”.

7. Now that the scale set up matches the HyperTerminal set up, type in the corresponding weight command per the Proto setting in the scale.

- Put some weight on the scale. Note display value (i.e. 1.58 lb).
- Go to the HyperTerminal screen and click the cursor on the blank screen.
- Type the required entry per chart to the right. Capital letters “W” must be used, a lower case “w” will not work. Note that the typed “W” does not get displayed unless Echo is checked in the HyperTerminal settings.

Weight Protocol	Proto	Type in
Mettler toledo	toLEdo	W
FedEx	Proto 1	W <CR>
WT SC320	Proto 2	W <CR>
WT SC3870	Proto 3	W <CR>
UPS	Proto 4	<CR>
Purolator	Proto 5	W <CR>
DHL	Proto 6	W <CR>
MT SICS	Proto 7	S <CR>

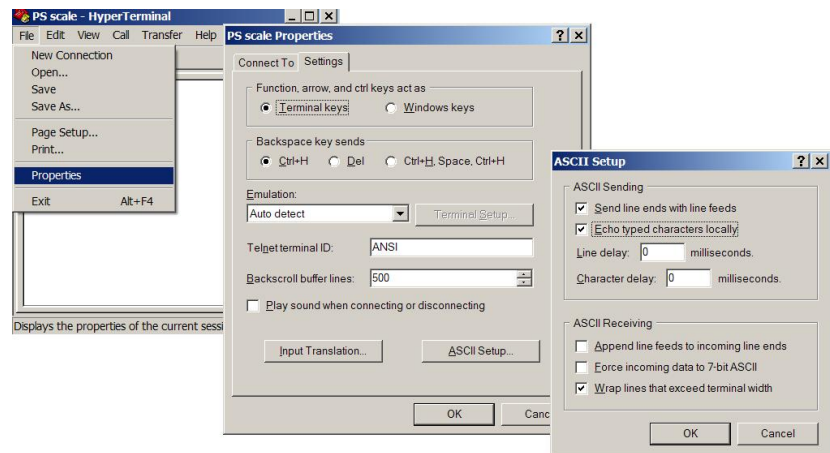

- A weight value should now be displayed on the HyperTerminal screen that matches the weight on the scale display. If another message appears, zero the scale first by repeating this step with no weight, than try again with a weight.

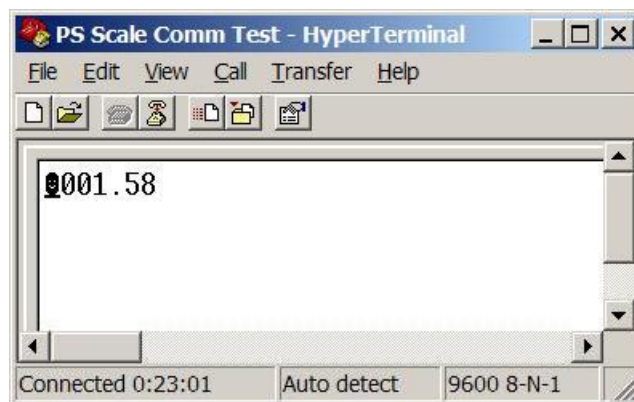

If the same weight is displayed on the scale and HyperTerminal screen:

***The scale is communicating correctly to the PC.  
Consult Shipping Software provider for further assistance.***

## Update Processor or Scale Software



**Note:** If there is NO SOCKET on the PCB board, than the processor is soldered directly to the PCB and can not be removed. Replace the PCB board and matching processor.

On most models of the PS scale, the processor on the main PCB board is attached through a socket that allows software updates or processor upgrades to the PCB.

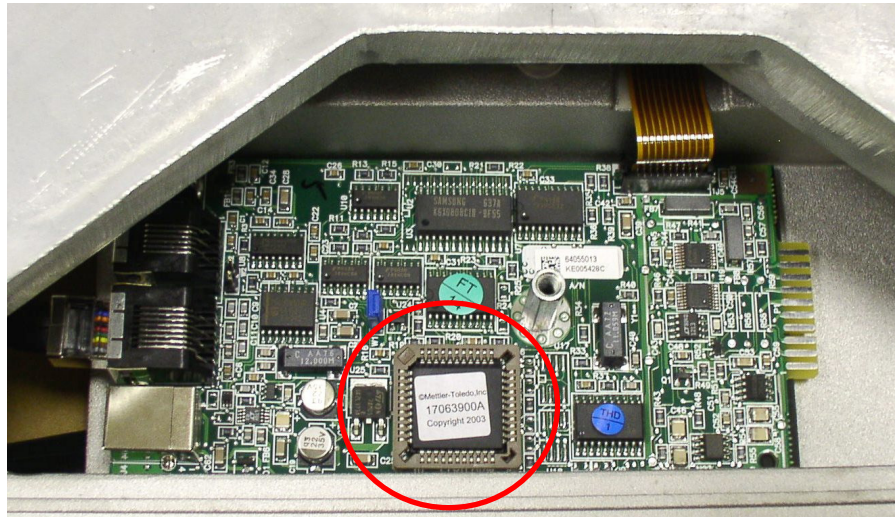

**Note:** Beveled corner of the socket is at the upper -left location. Processor is the black IC chip with the white label.

1. Record the set up data of the scale. See chapter 4
2. Remove power from the scale and remove platter
3. Make sure you are statically grounded with appropriate wrist wire or other means.
4. Remove PCB cover. Note, the scale connectors are attached to the PCB.
  - a. PS15 : Turn scale over, remove bolt, push on sides of plastic cover to release the cover tabs from the base slots.
  - b. PS60, 6L, 30 & 3L: On the top of the scale, unscrew the bolt that holds the PCB cover to the scale. Lift off cover.
  - c. PS90: Unloosen the two screws holding the connector/PCB cover to the scale base. PCB board is attached to the cover.
5. Locate socket (red circle on PCB photo above) and processor (Black IC chip with white label) on PCB board.
6. Pull processor out of the socket by the use of an IC chip extractor tool (MT Part Number 14608000A or equivalent). Insert extraction tool under the processor at one of the corners and pull up.
7. Position new processor above the PCB socket so the beveled corner of the processor is lined up with the bevel corner of the socket. Carefully press processor into socket.
8. Install PCB cover, and power up scale. Since there is no set up or calibration information on the new processor, an Error 3 code may appear. Press UNITS key and hold to access Setup mode. Enter required set up data and calibrate the scale per Chap 4.

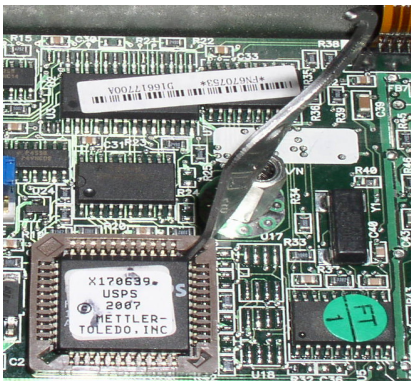



## Replace Main PCB

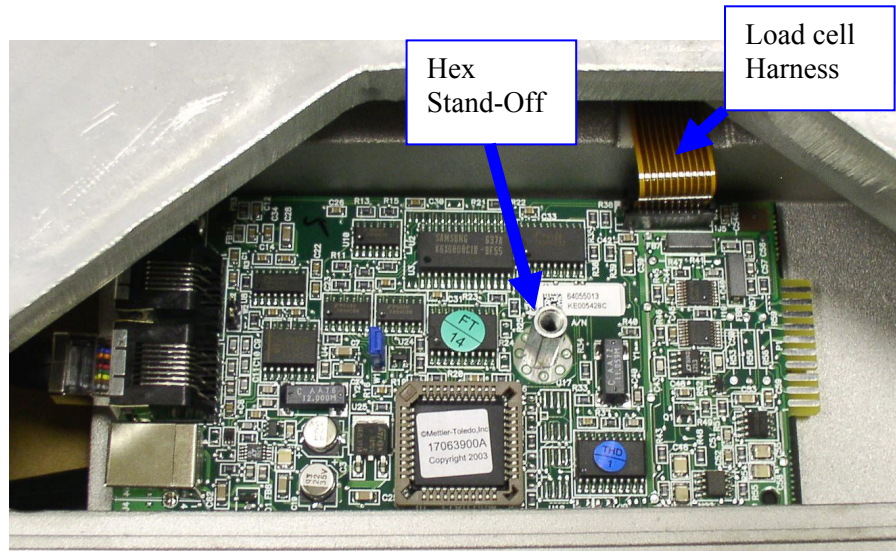

To replace the entire PCB board:

1. Record the set up data of the scale. See chapter 4
2. Remove power from the scale and remove platter
3. Make sure you are statically grounded with appropriate wrist wire or other means.
4. Disconnect the scale display cable, communication cable (USB / RS232), and power supply cable (if used) from the scale connectors.
5. Remove PCB cover. Note, the scale connectors are attached to the PCB.
  - a. PS15 : Turn scale over, remove bolt, push on sides of plastic cover to release the cover tabs from the base slots.
  - b. PS60, 6L, 30 & 3L: On the top of the scale, unscrew the bolt that holds the PCB cover to the scale. Lift off cover.
  - c. PS90: Unloosen the two screws holding the connector/PCB cover to the scale base. PCB board is attached to the cover.
6. Remove load cell harness from connector on PCB board (upper right corner).
  - a. PS60, 6L, 30, 3L, and 15: Carefully pull up black tabs on each side of connector and pull ribbon harness out.
  - b. PS90: Pull up on white tabs of harness connector.
7. Remove PCB board and leave insulator pad attached to scale.
  - a. PS15: Use 7 mm wrench and unscrew hex standoff where the bolt from the PCB cover was secured.
  - b. PS60, 6L, 30, and 3L: Use 6 mm wrench and unscrew hex standoff where the bolt from the PCB cover was secured.
  - c. PS90: PCB is attached by two screws. Use Phillips screw driver to remove large metal screw towards the center of the PCB board. Use small Phillips screw driver to remove plastic screw located at the edge of the PCB board on the back side of the Power Supply connector.
8. Install new PCB board by placing on the insulator pad, and bolt PCB to the scale in reverse order of step six. Hold PCB edges to keep board square as it is being secured.
9. If the new PCB was not ordered with a new processor, than install existing processor from the old PCB.

- a. Pull processor out of the socket by the use of a chip puller. Insert chip puller under the processor at one of the corners and pull up.
  - b. Position new processor above the PCB socket so the beveled corner of the processor is lined up with the bevel corner of the socket. Carefully press processor into socket.
10. Replace loadcell harness in reverse fashion to step 5.
  11. Install display cable and communication cable (USB or RS232) to the scale connector ports.
  12. Install PCB cover, and power up scale. An Error 3 code will appear indicating the scale needs to be reprogrammed and re-calibrated. Press UNITS key and hold to access Setup mode. Enter required set up data and calibrate the scale per Chap 4.

## Load Cell Replacement

For load cell replacement, please use correct load cell part number equivalent to the capacity on the data label. Contact Mettler Toledo Technical Service if you are not sure of the correct part number.

To change out the load cell:

1. Remove power from the scale and remove platter
2. Make sure you are statically grounded with appropriate wrist wire or other means.
3. Remove spider from the load cell by:
  - a. PS15: Use 5 mm Hex wrench to remove two socket head bolts on top of spider. Remove white plastic cover on spider.
  - b. PS60,6L,30, and 3L: Use 6 mm Hex wrench to remove two socket head bolts on top of spider
  - c. PS90: To expose loadcell bolts, remove 4 small black rubber covers on the center ridge of the top plate. Bolts are approximately 1 inch (2.5 cm) apart from each other. Use 5 mm Hex wrench to remove the 4 socket head bolts.
4. Remove PCB cover. Note, the scale connectors are attached to the PCB.
  - a. PS15 : Turn scale over, remove bolt, push on sides of plastic cover to release the cover tabs from the base slots.
  - b. PS60, 6L, 30 & 3L: On the top of the scale, unscrew the bolt that holds the PCB cover to the scale. Lift off cover.
  - c. PS90: Unloosen the two screws holding the connector/PCB cover to the scale base. PCB board is attached to the cover.
5. Remove load cell harness from connector on PCB board (upper right corner – see photo in previous section).
  - a. PS60, 6l, 30, 3L, and 15: Carefully pull up black tabs on each side of connector and pull ribbon harness out.
  - b. PS90: Pull up on white tabs of harness connector.
6. Turn scale over to access the bottom load cell bolts, and remove load cell from the scale base.
  - a. PS15: Use 5 mm Hex wrench to remove two bolts on bottom of base by the load cell harness.
  - b. PS60,6L, 30, and 3L: Use 6 mm Hex wrench to remove two bolts on bottom of scale base.
  - c. PS90: To expose load cell bolts, remove 4 small black rubber covers on the center ridge under the bottom plate. Bolts are approximately 1 inch

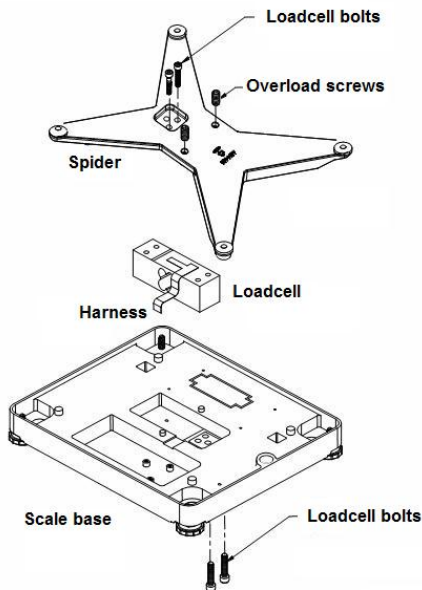

- (2.5 cm) apart from each other. Use 5 mm Hex wrench to remove the 4 bolts.
7. Install the new load cell to the scale base in the reverse fashion of step #6. Orient load cell so harness is in its proper position to attach to its connector.
    - a. PS15: Use 5 mm Hex wrench and torque screws to 85 in.lbs.
    - b. PS60,6L,30, and 3L: Use 6 mm Hex wrench and torque screws to 150 in.lbs.
    - c. PS90: Use 5 mm Hex wrench and torque screws to 150 in.lbs.
  8. Connect load cell harness to PCB board in reverse fashion from step #5.
  9. Attach the spider to the loadcell in the reverse fashion of step # 3.
    - a. PS15: Use 5 mm Hex wrench and torque screws to 85 in.lbs.
    - b. PS60,6L,30, and 3L: Use 6 mm Hex wrench and torque screws to 150 in.lbs.
    - c. PS90: Use 5 mm Hex wrench and torque screws to 150 in.lbs.
  10. Set overload protection by adjusting overload screws to the correct gap position from the overload stops on the scale base. Use a feeler gauge to set the gap.
    - a. PS15: Use 2mm hex wrench to adjust the single overload on bottom of scale. Overload is located on the base frame by the power supply connector. Set gap to 0.023" (0.58mm) +/- 0.003" (0.076mm)
    - b. PS60, 6L, 30, and 3L: Use 4 mm Hex wrench to adjust the two overloads. Set gap to 0.015" (0.38mm) +/- 0.003" (0.076mm)
    - c. PS90: Remove black covers to 6 overloads on top of scale. Use 10 mm wrench to loosen lock nut and 3 mm Hex wrench to adjust overloads. Set gap of two center overloads to 0.040" (1.02mm) +/- 0.005" (0.13mm), and gap of four outside overloads to 0.105" (2.67mm) +/- 0.007" (0.18mm).
  11. Attach PCB cover to scale in reverse fashion of step 4.
  12. Place platter on scale and power up the scale (USB or Power Supply).
  13. Calibrate the scale per chapter 4 and add metrology seal if required.

---

## Replacing the Base Mount Display

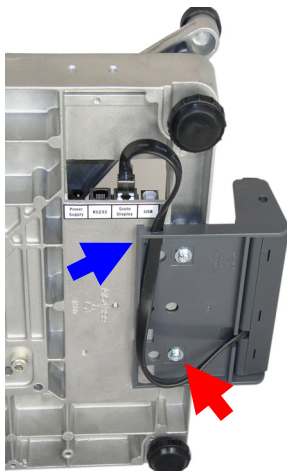

A base mount display unit (0270-1X00, 2-key indicator) can be installed if the base display needs to be replaced. To replace the base mount display:

1. Disconnect the cable from the Scale Display connector on the bottom of the scale. Push in tab and remove cable jack.
2. Remove old display bracket from the scale by loosening the two M4 10mm screws (P/N R0550100A) as shown by the red arrow (Note: PS90 utilizes two black clips).
3. With the display cable routed through the slot at the back of the mounting bracket (blue arrow), attach the new display unit to the bottom of the PS with the two M4 10mm screws.
4. Attach display cable to the connector labeled Scale Display.





FOR YOUR NOTES

---

# Interface

## Appendix A: Serial (RS232) Host

The scale does not reply to host weight commands if it is in calibration mode or if the scale cannot capture zero on power-up.

The METTLER TOLEDO PS shipping scale can function as a peripheral device to a host computer. In host mode you can:

- Calibrate the scale (Toledo Proto setting only)
- Configure setup parameters (Toledo Proto setting only)
- Request and receive weight data when the scale is in a stable state
- Request and receive the scale's status when the scale is in an unstable or invalid state
- Zero the scale and/or switch units (depending on setup)

This section presents information and instructions on how to use the PS in host mode.

---

## Communication Parameters

Data is transmitted and received by the scale through an RS-232 serial port connection. The following communication parameters are supported:

- Baud Rate (300, 1200, 2400, 4800, 9600, 19200)
- Parity (no, even, odd, mark, space)
- ASCII bit string (7 or 8)
- Stop bits (1, 2)
- The scale only responds to commands, continuous data output is not available.

---

## Protocols

The scale can be programmed to respond to a selected "menu" of defined protocols. The host sends requests to the scale in the form of ASCII data and control characters as determined by the selected protocol. The scale responds to the host with a string of ASCII characters. ASCII characters and their binary conversions are listed in the following table:

**ASCII Characters and Conversions**

ASCII CHAR.	DEC	HEX	76543210	ASCII CHAR.	DEC	HEX	76543210
NULL	0	00	00000000	SPACE	32	20	00100000
SOH	1	01	00000001	!	33	21	00100001
STX	2	02	00000010	"	34	22	00100010
ETX	3	03	00000011	#	35	23	00100011
EOT	4	04	00000100	\$	36	24	00100100
ENQ	5	05	00000101	%	37	25	00100101
ACK	6	06	00000110	&	38	26	00100110
BELL	7	07	00000111	'	39	27	00100111
Backspace	8	08	00001000	(	40	28	00101000
TAB	9	09	00001001	)	41	29	00101001
Line Feed	10	0A	00001010	*	42	2A	00101010
Verf. Tab	11	0B	00001011	+	43	2B	00101011
Form Feed	12	0C	00001100	,	44	2C	00101100
Carr. Return	13	0D	00001101	-	45	2D	00101101
Shift Out	14	0E	00001110	.	46	2E	00101110
Shift In	15	0F	00001111	/	47	2F	00101111
Data Link Esc	16	10	00010000	0	48	30	00110000
DC1	17	11	00010001	1	49	31	00110001
DC2	18	12	00010010	2	50	32	00110010
DC3	19	13	00010011	3	51	33	00110011
DC4	20	14	00010100	4	52	34	00110100
NAK	21	15	00010101	5	53	35	00110101
SYNCH IDLE	22	16	00010110	6	54	36	00110110
End Trans.	23	17	00010111	7	55	37	00110111
CANCEL	24	18	00011000	8	56	38	00111000
End Of Medium	25	19	00011001	9	57	39	00111001
Substitute	26	1A	00011010	:	58	3A	00111010
ESCAPE	27	1B	00011011	;	59	3B	00111011
FS (Cur. Right)	28	1C	00011100	<	60	3C	00111100
GS (Cur. Left)	29	1D	00011101	=	61	3D	00111101
RS (Cursor Up)	30	1E	00011110	>	62	3E	00111110
US (Cur. Down)	31	1F	00011111	?	63	3F	00111111

Appendix A: Serial Host Interface

ASCII CHAR.	DEC	HEX	76543210	ASCII CHAR.	DEC	HEX	76543210
@	64	40	01000000	`	96	60	01100000
A	65	41	01000001	a	97	61	01100001
B	66	42	01000010	b	98	62	01100010
C	67	43	01000011	c	99	63	01100011
D	68	44	01000100	d	100	64	01100100
E	69	45	01000101	e	101	65	01100101
F	70	46	01000110	f	102	66	01100110
G	71	47	01000111	g	103	67	01100111
H	72	48	01001000	h	104	68	01101000
I	73	49	01001001	i	105	69	01101001
J	74	4A	01001010	j	106	6A	01101010
K	75	4B	01001011	k	107	6B	01101011
L	76	4C	01001100	l	108	6C	01101100
M	77	4D	01001101	m	109	6D	01101101
N	78	4E	01001110	n	110	6E	01101110
O	79	4F	01001111	o	111	6F	01101111
P	80	50	01010000	p	112	70	01110000
Q	81	51	01010001	q	113	71	01110001
R	82	52	01010010	r	114	72	01110010
S	83	53	01010011	s	115	73	01110011
T	84	54	01010100	t	116	74	01110100
U	85	55	01010101	u	117	75	01110101
V	86	56	01010110	v	118	76	01110110
W	87	57	01010111	w	119	77	01110111
X	88	58	01011000	x	120	78	01111000
Y	89	59	01011001	y	121	79	01111001
Z	90	5A	01011010	z	122	7A	01111010
[	91	5B	01011011	{	123	7B	01111011
\	92	5C	01011100		124	7C	01111100
]	93	5D	01011101	}	125	7D	01111101
^	94	5E	01011110	~	126	7E	01111110
_	95	5F	01011111		127	7F	01111111



**Toledo Protocol Host Commands**

Following is a listing of host commands and scale responses. Brackets "< >" are used to indicate that the characters within are a description of the transmitted data and are not part of the transmitted data string. <STX> indicates an ASCII Start Of Text character (HEX 02). <CR> indicates an ASCII Carriage Return (HEX 0D).

<b>Host Command</b>	<b>Description</b>	<b>Scale Response</b>
W*	Send normal resolution weight data.	<STX>XXX.XX<CR> (for PS90,60,30,15 lb builds) or <STX>XXXlbXX.Xoz<CR> (for PS6L, 3L, 15 lb-oz build) <STX>XXXX.X<CR> (for PS90: 300 x 0.1 lb build) <STX>XXX.XX<CR> (PS90,60,30 kg build) <STX>XX.XXX<CR> ( PS15 Kg or 0.005 lb increment) For PS6L 150 x 0.005 lb Multi-Range build) <STX>XX.XXX<CR> (x 0.005 lb increment) <STX>XXX.XX<CR> (x 0.05 lb increment) <STX>XXXX.X<CR> (x 0.1 lb increment) or <STX>?<StatusByte><CR> (if current weight is invalid)
H	Send high resolution weight data.	<STX>XXX.XXX<CR> (for PS-90,60,30,15 lb builds) or <STX>XXXXXX<CR> (for PS6L 150 lb-oz build) or <STX>XXX.XXX<CR> (for PS6L 150 x 0.005 lb build) <STX>XXXX.XX<CR> (for PS90: 300 x 0.1 lb build) <STX>XX.XXXX<CR> (for PS15) or <STX>?<StatusByte><CR> (if current weight is invalid)
Z	Zero scale unless in motion or out of range under or over capacity.	<STX>?<status byte><CR> Scale status byte.
A	Perform a confidence test of RAM, ROM, and EEPROM. Store results of tests in confidence status byte for later retrieval.	<STX><CR> The scale echoes back a <STX><CR> indicating the command was received.
B	Send results of confidence test.	<STX>?<confidence byte><CR> Confidence test status byte.
C	Initiate host interface scale configuration.	<STX>CALIBRATE?<CR>, See below
S	Initiate host interface setup.	<STX>SETUP?<CR>, See below
E	Enter "echo" serial port test mode. All characters sent to the scale will be echoed back to the host. "F" terminates the test.	<STX>E<CR> The scale echoes back the letter E indicating the command was received.
F	Exit "echo" serial port test mode.	<STX>F<CR> The scale echoes back the letter F indicating the command was received.
L	Switch to and send standard weight.	Same as for W above.
K	Switch to and send metric weight.	Same as for W above.

**Table Note:**\* A status byte message <STX>?<status byte><CR> is sent in place of the requested weight data field if the scale is in motion, under zero, or over capacity when the weight data request is sent. The question mark "?" indicates that the following data is a non-ASCII status byte rather than weight data. See below for status byte definitions.

## Scale Status Byte Format

When communicating in host mode using the standard Toledo protocol, the PS may send status bytes containing information such as motion and over/under-capacity conditions. The message `<STX>?<status byte><CR>` indicates transmission of a status byte. The status byte sent is an ASCII character that must be converted to binary form for decoding the bits. The ASCII character table with binary conversion (given in the previous section) can be used to convert status bytes. The bits of the status byte in the standard Toledo protocol are defined as follows:

Status Byte	
Bit No.	Bit Description
6	Always 1
5	Always 1
4	1 = Center of zero 0 = Not at center of zero
3	1 = Outside zero capture range 0 = Within range
2	1 = Under zero 0 = Within weighing range
1	1 = Over capacity 0 = Within weighing range
0	1 = Scale in motion 0 = Stable weight data

## Scale Confidence Byte Format

When communicating in host mode using the standard Toledo protocol, the host may ask the PS to store and send confidence bytes containing information about RAM, ROM, and EEPROM testing. The message `<STX>?<confidence byte><CR>` indicates transmission of a confidence byte. The confidence byte sent is an ASCII character that must be converted to binary form for decoding the bits. The ASCII character table with binary conversion (given in the previous section) can be used to convert status bytes. The bits of the confidence byte in the standard Toledo protocol are defined as follows:

Status Byte	
Bit No.	Bit Description
6	1 = New status data available. 0 = Host has read data.
5	Bit is always a 0.
4	1 = ROM test failed. 0 = ROM test passed.
3	1 = RAM test failed. 0 = RAM test passed.
2	Bit is always a 0.
1	1 = Calibration Required. 0 = Calibration Data OK
0	1 = EEPROM test failed 0 = EEPROM test passed.

## Calibrate Using Host Interface

The PS shipping scale can be calibrated using the host interface. The command to initiate the calibration sequence is available in the METTLER TOLEDO command set. Calibration is based on the current scale configuration for units and capacity/increment. These can be changed (through the keypad or the host interface) before calibrating the scale through the host interface.

To calibrate using the host interface:

1. Remove the platter, break the legal-for-trade seal (if present), and remove the sub-platter to give access to the PCB.
2. Remove the calibration jumper (W1). Refer to the calibration diagram in Chapter 4 of this manual. DO NOT ENTER SETUP MODE. The PS does not respond to host commands in calibration mode.
3. Send the command **C** to initiate calibration sequence. The scale responds **<STX>CALIBRATE?<CR><LF>**.
4. Send the command **Y** to continue with the calibration sequence, or send the command **N** to abort the sequence. The scale responds **<STX>UNLOAD SCALE- Y?<CR><LF>**.
5. Remove any weight on the platter and send the command **Y** to continue. A stable zero reading is taken, then the scale responds **<STX> ADD (Weight Value) (Weight Units) Y? <CR><LF>**

**Note:** The weight value and weight units used in calibrating the scale can be set through the Host command "S" as described in the next section.

**(Weight Value)** = weight amount (two or three digit number) to add to scale  
**(Weight Unit)** = LB or KG

6. Add the requested calibration weight to the scale, then send the command Y to continue. The scale responds  
`<STX> CAL DONE <CR><LF>` or  
`<STX> INCORRECT AMOUNT OF WEIGHT <CR><LF>`.

---

## Configure Scale Parameters Using Host Interface

Configuration parameters can also be sent using the host interface. A command to send a new scale configuration over the host interface is available in the METTLER TOLEDO command set.

To configure using the host interface:

1. From the host computer, send the host command **S** to initiate the configuration setup sequence. The scale responds with the current set bytes:

`<STX>X1X2X3X4X5X6X7X8X9X10X11X12X13X14X15X16X17X18X19X20<CR>`

2. Determine the command string representing the configuration parameters that are desired. The command string consists of 22 characters beginning with an ASCII `<STX>` and terminated with an ASCII `<CR>`. The command string represents a 10-byte bit-mapped setup array stored in EEPROM. The 10-byte array is expanded for serial transmission so that the high-order four bits of each byte are zeroes and the low-order four bits are numbers representing the desired option for each program block. See the table below for definitions of each byte.

The table below lists the programming options available in each program block as they are used in Host Interface Setup. When downloading the scale setup it is strongly recommended that you modify only the selections that you need to change in the current setup bytes sent by the scale. Leave the values of all other setup bytes as they were when sent from the scale (including the selections that are currently not used). Then send the modified setup bytes string back to the scale.

## METTLER TOLEDO PS Shipping Scale: Technical Manual

X<sub>1</sub> = Not Used, Set to 0x00.

X<sub>2</sub> = Not Used, Set to 0x00.

X<sub>3</sub> = Not Used, Set to 0x00.

X<sub>4</sub> = GEO Entry Required:

0x01 = GEO Entry Required OFF

0x02 = GEO Entry Required ON

X<sub>5</sub> = Units Switching:

0x01 = Units Switching OFF

0x02 = Units Switching ON

X<sub>6</sub> = Zero Cursor:

0x01 = Zero Cursor OFF

0x02 = Zero Cursor ON

X<sub>7</sub> = Not Used, Set to 0x00.

X<sub>8</sub> = Sleep Mode:

0x01 = Sleep Mode OFF

0x02 = Sleep Mode ON

X<sub>9</sub> = Serial Port Protocol:

0x01 = Disabled

0x02 = Mettler Toledo

0x03 = FedEx

0x04 = Weightronix WT320

0x05 = Weightronix WT3870

0x06 = UPS

0x07 = Purolator

0x08 = Airborne

X<sub>10</sub> = Stop Bit:

0x01 = One Stop Bit

0x02 = Two Stop Bits

X<sub>11</sub> = Parity Bit:

0x01 = Space Parity Bit

0x02 = Mark Parity Bit

0x03 = Odd Parity Bit

0x04 = Even Parity Bit

0x05 = No Parity Bit

X<sub>12</sub> = Data Bits:

0x01 = 7 Data Bits

0x02 = 8 Data Bits

X<sub>13</sub> = Baud Rate:

0x01 = 300 Baud

0x02 = 1200 Baud

0x03 = 2400 Baud

0x04 = 4800 Baud

0x05 = 9600 Baud

0x06 = 19200 Baud

X<sub>14</sub> = Weight Filter:

0x01 = Light Filter

0x02 = Medium Filter

0x03 = Heavy Filter

X<sub>15</sub> = Weight Display Mode:

0x01 = Factory Test Mode (DLC Echo)

0x02 = Expanded (X10) Weight Display

0x03 = Normal Weight Display

0x04 = Weight Classifier Display

0x05 = USPS Rounding (**PS30 only**)

X<sub>16</sub> = Power up Units:

0x01 = Metric (kg)

0x02 = Pounds (lb)

X<sub>17</sub> = Scale Build:

Select capacity and increment size

X <sub>17</sub>	Units	PS15	PS30/3L	PS60/6L	PS90
0x01	kg	15 x 0.005	30 x 0.02	60 x 0.01	60 x 0.02
	lb	30 x 0.01	70 x 0.05	150 x 0.02	150 x 0.05
0x02	kg	15 x 0.002	30 x 0.01	60 x 0.02	100 x 0.05
	lb	30 x 0.005	70-NR	150 x 0.05	250 x 0.1
0x03	kg	15-NI	30-NI	45 x 0.05	150 x 0.05
	lb	30-NO	70-NI	100-NO	300 x 0.1
0x04	kg	15-NC		45 x 0.02	150 x 0.05
	lb		70-NO	100 x 0.05	
0x05	kg			60-NI	60 x 0.05
	lb			150-NI	149-NI
0x06	kg			70-NI	90 x 0.1
	lb			149-NI	200-NI
0x07	kg			60-NC	
	lb			150-N5	
0x08	kg			45-NI	
	lb			100-NI	

See Chapter 4: **Build** Program Block for further details on each option as to the capacity size, increment size, range capability, and if unit switching (**Alt**) is permitted.

X<sub>18</sub> = CAL WT

Select Calibration weight to be used:

Scale	Units	Calibration Weight Options - X <sub>18</sub>			
		0x01	0x02	0x03	0x04
PS15	Pounds-lb	5	10	15	20
	Metric-kg	2	5	7	10
PS30 PS3L	Pounds-lb	5	25	30	50
	Metric-kg	2	10	15	20
PS60U PS6L	Pounds-lb	25	50	75	100
	Metric-kg	10	20	30	45
PS90U	Pounds-lb	25	50	70	100
	Metric-kg	10	20	25	45

X<sub>19</sub> = Pushbutton Zero Capture Range:

0x01 = +/- 2% of scale capacity

0x02 = +/- 5% of scale capacity

0x03 = +/- 100% of scale capacity

X<sub>20</sub> = Not Used, Set to 0x00.

You can obtain the current configuration by sending the S command. Then you can abort without changing by sending the A command to abort.

Before sending the **DONE** reply, the configuration file is analyzed just as if it had been constructed using the keyboard.

3. Send the command with the desired set of bytes (Y) to the scale:  
**<STX>Y<sub>1</sub>Y<sub>2</sub> ... Y<sub>19</sub>Y<sub>20</sub><CR>**
4. The scale will check to make sure the requested bytes are valid, then will echo the request:  
**<STX>Y<sub>1</sub>Y<sub>2</sub> ... Y<sub>19</sub>Y<sub>20</sub><CR>**  
Or, if there were problems with the request, the scale returns the original, **unmodified** setup bytes to let the host know there was a problem:  
**<STX>X<sub>1</sub>X<sub>2</sub> ... X<sub>19</sub>X<sub>20</sub><CR>**
5. Send the command **Y** to continue and store the new setup bytes and the scale will respond with  
**<STX>DONE<CR>** when configuration is complete or  
**<STX>ABORT<CR>** if the modified bytes had problems.

NOTE: At any time the Host can send an **N** command to abort the Setup Download mode.



FOR YOUR NOTES

## Appendix B: USB Host Interface

The USB 1.1 full speed (12Mbps) interface on this scale is used in applications where a USB interface, which conforms to the Microsoft™ USB POS HID, is required.

---

### References

The following documents can be found on the official USB Web page.

- Universal Serial Bus Specifications, Revision 2.0  
<http://www.usb.org/developers/docs/>
- Universal Serial Bus Device Class Definition for Human Interface Devices (HID), Version 1.11  
[http://www.usb.org/developers/devclass\\_docs/HID1\\_11.pdf](http://www.usb.org/developers/devclass_docs/HID1_11.pdf)
- Universal Serial Bus HID Usage tables, Version 1.12  
[http://www.usb.org/developers/devclass\\_docs/Hut1\\_12.pdf](http://www.usb.org/developers/devclass_docs/Hut1_12.pdf)
- Universal Serial Bus HID Point of Sale Usage Tables, Version 1.02  
[http://www.usb.org/developers/devclass\\_docs/pos1\\_02.pdf](http://www.usb.org/developers/devclass_docs/pos1_02.pdf)

---

### Hardware

The scale communication to the PC host is via a standard full speed (12Mbps) USB interface cable. This cable will connect to a Series B type receptacle on the scale.

---

### Electrical Connection

The scale supports one USB 1.1 full speed interface (12Mbps). Refer to Universal Serial Bus Specification Revision 2.0 for details on signal termination, signal levels and other electrical specifications for the USB interface.



## Power

The PS scale can be considered bus powered as a low power device because it consumes less than 1 unit load of power (<100ma) with up to two non-backlit displays connected. It does not fully comply with the USB specifications because it does not support the "suspend state".

---

## Protocol

This interface supports the standard Universal Serial Bus HID Point of Sale Usage Tables for scales. Refer to the Universal Serial Bus HID Point of Sale Usages Tables document for details on this protocol.

Mettler Toledo has additional information to assist software developers to communicate to the PS scales by USB. Please request document **64068935, USB Protocol Specifications for PS Scales**, from your local Mettler Toledo representative or call 1-800-786-0812. In addition to the usage tables referenced above, this document includes the vendor extensions for full PS scale functionality.



FOR YOUR NOTES



**METTLER TOLEDO**  
1900 Polaris Parkway  
Columbus, Ohio 43240-2020

P/N: 64067860

(08/09)

METTLER TOLEDO® is a Trademark of Mettler Toledo International, Inc.  
© 2009 **METTLER TOLEDO**.  
Printed in U.S.A.